

**PHILIPS**

Signage Display

4000 Series

98BDL4650D



## User Manual (English)

# Table Of Contents

1. Safety Instructions .....	1	8. Supported Media Formats.....	69
2. Unpacking and Installation.....	10	9. Input Mode .....	71
2.1. Unpacking .....	10	10. Pixel Defect Policy .....	73
2.2. Package Contents.....	13	10.1. Pixels and Sub-Pixels.....	73
2.3. Installation Notes .....	13	10.2. Types of Pixel Defects + Dot Definition.....	73
2.4. Mounting on a Wall .....	14	10.3. Bright Dot Defects.....	73
2.5. Mounting in Portrait Orientation .....	15	10.4. Dark Dot Defects .....	74
3. Parts and Functions .....	16	10.5. Proximity of Pixel Defects .....	74
3.1. Control Panel .....	16	10.6. Pixel Defect Tolerances .....	74
3.2. Input/Output Terminals.....	17	10.7. MURA.....	74
3.3. Remote Control.....	18	11. Cleaning and Troubleshooting .....	75
3.4. Inserting the batteries in the remote control .....	22	11.1. Cleaning .....	75
3.5. Handling the remote control.....	22	11.2. Troubleshooting .....	76
3.6. Operating range of the remote control ....	22	12. Technical Specifications.....	77
3.7. USB Cover .....	23	Warranty policy for Philips Professional Display Solutions .....	79
3.8. AC Switch Cover.....	24	Index.....	81
3.9. Installing the 4G module .....	25		
4. Connecting External Equipment .....	26		
4.1. Connecting External Equipment (Multimedia Player) .....	26		
4.2. Connecting a PC.....	26		
4.3. Connecting Audio Equipment.....	27		
4.4. Connecting Multiple Displays in a Daisy-chain Configuration .....	28		
4.5. IR connection.....	28		
4.6. IR Pass-through Connection.....	28		
4.7. Wire-connecting to Network.....	29		
5. Operation .....	30		
5.1. Watch the Connected Video Source.....	30		
5.2. Change Picture Format.....	30		
5.3. Overview .....	30		
5.4. Media Player .....	32		
5.5. Browser.....	35		
5.6. PDF Player .....	39		
5.7. Custom App .....	42		
6. Setting .....	43		
6.1. Settings.....	43		
6.2. Supplementary.....	57		
7. OSD Menu .....	59		
7.1. Navigating the OSD Menu .....	59		
7.2. OSD Menu Overview .....	59		

# 1. Safety Instructions

## Safety precautions and maintenance



**WARNING:** Use of controls, adjustments or procedures other than those specified in this documentation may result in exposure to shock, electrical hazards and/or mechanical hazards.

**Read and follow these instructions when connecting and using your display:**

This product is intended for use in professional installations in business settings only and is not suitable for domestic purposes. Any use other than that for which this device is intended can void the warranty.

This product contains an operating system. If it is shut down directly using the AC switch, it may damage the program and prevent it from powering on again. If the system is unable to power on due to frequent shutdowns, please try a factory reset. Please note that all data stored in the system will be lost when the display is rebooted after a factory reset.

### Operation:

- Keep the display out of direct sunlight and away from stoves or any other heat sources.
- Keep the display away from oil, otherwise the plastic cover may be damaged.
- It is recommended to set the display up in the well-ventilated place.
- Ultra-violet ray filter is necessary of outdoor operation.
- If the product will be used in extreme conditions such as high temperature, humidity, display patterns or operation time etc... It is strongly recommended to contact Philips for Application engineering advice. Otherwise, its reliability and function may not be guaranteed. Extreme conditions are commonly found at Airports, Transit Stations, Banks, Stock market, and Controlling systems.
- Remove any object that could fall into ventilation holes or prevent proper cooling of the display's electronics.
- Do not block the ventilation holes on the cabinet.
- When positioning the display, make sure the power plug and outlet are easily accessible.
- When turning off the display by detaching the power cord, wait 6 seconds before re-attaching the power cord for normal operation.
- Ensure the use of an approved power cord provided by Philips at all times. If your power cord is missing, please contact your local service center.
- Do not subject the display to severe vibration or high impact conditions during operation.
- Do not knock or drop the display during operation or transportation.
- The eye bolt is for usage in short-time maintenance and installation. We suggest not to use the eye bolt for more than 1 hour. Prolong usage is prohibited. Please keep a clear safety area under the display while using the eye bolt.
- If provided with a 3-pin attachment plug on the power cord, plug the cord into a grounded (earthed) 3-pin outlet. Do not disable the power cord grounding pin, for example, by attaching a 2-pin adapter. The grounding pin is an important safety feature.

### Maintenance:

- To protect your display from possible damage, do not put excessive pressure on the LCD panel. When moving your display, grasp the frame to lift; do not lift the display by placing your hand or fingers on the LCD panel.
- Unplug the display if you are not going to use it for an extensive period of time.
- Unplug the display if you need to clean it with a slightly damp cloth. The screen may be wiped with a dry cloth when the power is off. However, never use organic solvent, such as, alcohol, or ammonia-based liquids to clean your display.
- To avoid the risk of shock or permanent damage to the set, do not expose the display to dust, rain, water or an excessively moist environment.
- If your display becomes wet, wipe it with dry cloth as soon as possible.
- If a foreign substance or water gets in your display, turn the power off immediately and disconnect the power cord. Then remove the foreign substance or water, and send the unit to the maintenance center.
- Do not store or use the display in locations exposed to heat, direct sunlight or extreme cold.
- In order to maintain the best performance of your display and ensure a longer lifetime, we strongly recommend using the display in a location that falls within the following temperature and humidity ranges.
- Keep the display dry. To avoid electric shock, do not expose it to rain or excessive moisture.

- Environmental absolute ratings

Item	Min.	Max.	Unit
Storage temperature	-20	60	°C
Operation temperature	0	40	°C
Glass Surface temperature (Operation)	0	65	°C
Storage humidity	5	95	% RH
Operating humidity	20	80	% RH

- LCD panel temperature need to be 25 degrees Celsius at all time for better luminance performance.
- Only the lifetime of the display stated in this specification is guaranteed if the display is used under the proper operation conditions.

**IMPORTANT:** Always activate a moving screen saver program when you leave your display unattended. Always activate a periodic screen refresh application if the unit will display unchanging static content. Uninterrupted display of still or static images over an extended period may cause “burn in”, also known as “after-imaging” or “ghost imaging”, on your screen. This is a well-known phenomenon in LCD panel technology. In most cases, the “burned in” or “after-imaging” or “ghost imaging” will disappear gradually over a period of time after the power has been switched off.

**WARNING:** Severe “burn-in” or “after-image” or “ghost image” symptoms will not disappear and cannot be repaired. This is also not covered under the terms of your warranty.

**Service:**

- The casing cover should be opened only by qualified service personnel.
- If there is any need for repair or integration, please contact your local service center.
- Do not leave your display under direct sunlight.



If your display does not operate normally, having followed the instructions set out in this document, please contact a technician or your local service center.

**Stability Hazard.**

The device may fall, causing serious personal injury or death. To prevent injury, this device must be securely attached to the floor/wall in accordance with the installation instructions.



## EU Declaration of Conformity

This device complies with the requirements set out in the Council Directive on the Approximation of the Laws of the Member States relating to Electromagnetic Compatibility (2014/30/EU), Low-voltage Directive (2014/35/EU), RoHS directive (2011/65/EU), ErP directive (2009/125/EC).

This product has been tested and found to comply with the harmonized standards for Information Technology Equipment, these harmonized standards published under Directives of Official Journal of the European Union.

### ESD Warnings

When user close to the monitor may cause the equipment discharge and reboot to the display of main menu.

### Warning:

This equipment is compliant with Class A of EN55032/CISPR 32. In a residential environment this equipment may cause radio interference.

## Federal Communications Commission (FCC) Notice (U.S. Only)



**NOTE:** This equipment has been tested and found to comply with the limits for a Class A digital device, pursuant to part 15 of the FCC Rules. These limits are designed to provide reasonable protection against harmful interference when the equipment is operated in a commercial environment. This equipment generates, uses, and can radiate radio frequency energy and, if not installed and used in accordance with the instruction manual, may cause harmful interference to radio communications. Operation of this equipment in a residential area is likely to cause harmful interference in which case the user will be required to correct the interference at his own expense.



Changes or modifications not expressly approved by the party responsible for compliance could void the user's authority to operate the equipment.

Use only an RF shielded cable that was supplied with the display when connecting this display to a computer device.

To prevent damage which may result in fire or shock hazard, do not expose this appliance to rain or excessive moisture.

This device complies with Part 15 of the FCC Rules. Operation is subject to the following two conditions: (1) This device may not cause harmful interference, and (2) this device must accept any interference received, including interference that may cause undesired operation.

TPV USA Corp  
6525 Carnegie Blvd #200  
Charlotte, NC 28211  
USA

## Polish Center for Testing and Certification Notice

The equipment should draw power from a socket with an attached protection circuit (a three-prong socket). All equipment that works together (computer, display, printer, and so on) should have the same power supply source.

The phasing conductor of the room's electrical installation should have a reserve short-circuit protection device in the form of a fuse with a nominal value no larger than 16 amperes (A).

To completely switch off the equipment, the power supply cable must be removed from the power supply socket, which should be located near the equipment and easily accessible.

A protection mark "B" confirms that the equipment is in compliance with the protection usage requirements of standards PN-93/T-42107 and PN-89/E-06251.

### ***Wymagania Polskiego Centrum Badań i Certyfikacji***

Urządzenie powinno być zasilane z gniazda z przyłączonym obwodem ochronnym (gniazdo z kolkiem). Współpracujące ze sobą urządzenia (komputer, monitor, drukarka) powinny być zasilane z tego samego źródła.

Instalacja elektryczna pomieszczenia powinna zawierać w przewodzie fazowym rezerwową ochronę przed zwarciami, w postaci bezpiecznika o wartości znamionowej nie większej niż 16A (amperów).

W celu całkowitego wyłączenia urządzenia z sieci zasilania, należy wyjąć wtyczkę kabla zasilającego z gniazdka, które powinno znajdować się w pobliżu urządzenia i być łatwo dostępne.

Znak bezpieczeństwa "B" potwierdza zgodność urządzenia z wymaganiami bezpieczeństwa użytkownika zawartymi w PN-93/T-42107 i PN-89/E-06251.

### ***Pozostałe instrukcje bezpieczeństwa***

- Nie należy używać wtyczek adapterowych lub usuwać kolka obwodu ochronnego z wtyczki. Jeżeli konieczne jest użycie przedłużacza to należy użyć przedłużacza 3-żyłowego z prawidłowo połączonym przewodem ochronnym.
- System komputerowy należy zabezpieczyć przed nagłymi, chwilowymi wzrostami lub spadkami napięcia, używając eliminatora przepięć, urządzenia dopasowującego lub bezzakłócenowego źródła zasilania.
- Należy upewnić się, aby nic nie leżało na kablach systemu komputerowego, oraz aby kable nie były umieszczone w miejscu, gdzie można byłoby na nie nadeptywać lub potykać się o nie.
- Nie należy rozlewać napojów ani innych płynów na system komputerowy.
- Nie należy wpychać żadnych przedmiotów do otworów systemu komputerowego, gdyż może to spowodować pożar lub porażenie prądem, poprzez zwarcie elementów wewnętrznych.
- System komputerowy powinien znajdować się z dala od grzejników i źródeł ciepła. Ponadto, nie należy blokować otworów wentylacyjnych. Należy unikać kładzenia luźnych papierów pod komputer oraz umieszczania komputera w ciasnym miejscu bez możliwości cyrkulacji powietrza wokół niego.

## Electric, Magnetic and Electromagnetic Fields ("EMF")

1. We manufacture and sell many products targeted at consumers, which, like any electronic apparatus, in general have the ability to emit and receive electromagnetic signals.
2. One of our leading Business Principles is to take all necessary health and safety measures for our products, to comply with all applicable legal requirements and to stay well within the EMF standards applicable at the time of producing the products.
3. We are committed to develop, produce and market products that cause no adverse health effects.
4. We confirm that if its products are handled properly for their intended use, they are safe to use according to scientific evidence available today.
5. We play an active role in the development of international EMF and safety standards, enabling us to anticipate further developments in standardization for early integration in its products.

## Information for U.K. only

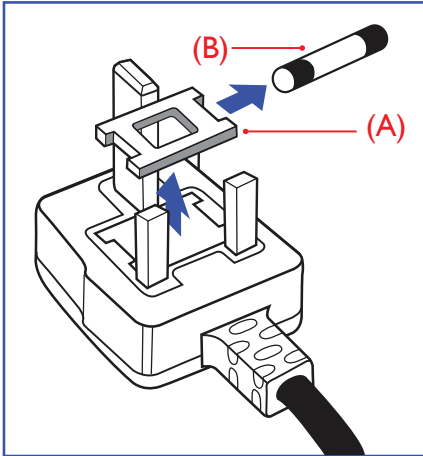

### WARNING - THIS APPLIANCE MUST BE EARTHED.

#### Important:

This apparatus is supplied with an approved moulded 13A plug. To change a fuse in this type of plug proceed as follows:+

1. Remove fuse cover and fuse.
2. Fit new fuse which should be a BS 1362 5A, A.S.T.A. or BSI approved type.
3. Refit the fuse cover.

If the fitted plug is not suitable for your socket outlets, it should be cut off and an appropriate 3-pin plug fitted in its place.

If the mains plug contains a fuse, this should have a value of 5A. If a plug without a fuse is used, the fuse at the distribution board should not be greater than 5A.

NOTE: The severed plug must be destroyed to avoid a possible shock hazard should it be inserted into a 13A socket elsewhere.

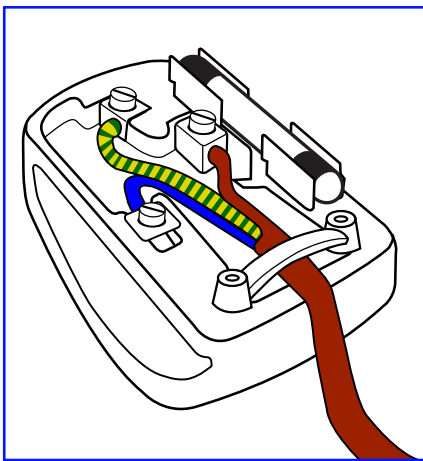

### How to connect a plug

The wires in the mains lead are coloured in accordance with the following code:

BLUE - "NEUTRAL" ("N")

BROWN - "LIVE" ("L")

GREEN & YELLOW - "EARTH" ("E")

1. The GREEN & YELLOW wire must be connected to the terminal in the plug which is marked with the letter "E" or by the Earth symbol or coloured GREEN or GREEN & YELLOW.
2. The BLUE wire must be connected to the terminal which is marked with the letter "N" or coloured BLACK.
3. The BROWN wire must be connected to the terminal which marked with the letter "L" or coloured RED.

Before replacing the plug cover, make certain that the cord grip is clamped over the sheath of the lead - not simply over the three wires.

## North Europe (Nordic Countries) Information

Placering/Ventilation

#### VARNING:

FÖRSÄKRA DIG OM ATT HUVUDBRYTARE OCH UTTAG ÄR LÄTÅTKOMLIGA, NÄR DU STÄLLER DIN UTRUSTNING PÅPLATS.

Placering/Ventilation

#### ADVARSEL:

SØRG VED PLACERINGSFOR, AT NETLEDNINGENS STIK OG STIKKONTAKT ER NEMT TILGÆNGELIGE.

Paikka/Ilmankierto

#### VAROITUS:

SIIJOITA LAITE SITEN, ETTÄ VERKKOJOHTO VOIDAAN TARVITTAESSA HELPOSTI IRROTTAA PISTORASIESTA.

Plassering/Ventilasjon

#### ADVARSEL:

NÅR DETTE UTSTYRET PLASSERES, MÅ DU PASSE PÅ AT KONTAKTENE FOR STØMTILFØRSEL ER LETTE Å NÅ.

## China RoHS

根据中国大陆《电器电子产品有害物质限制使用管理办法》，以下部分列出了本产品中可能包含的有害物质的名称和含量。

部件名称	有害物质					
	铅 (Pb)	汞 (Hg)	镉 (Cd)	六价铬 (Cr (VI))	多溴联苯 (PBB)	多溴二苯醚 (PBDE)
外壳	O	O	O	O	O	O
液晶显示屏	X	O	O	O	O	O
电路板组件*	X	O	O	O	O	O
电源适配器	X	O	O	O	O	O
电源线/连接线	X	O	O	O	O	O
遥控器	X	O	O	O	O	O

本表格依据SJ/T 11364 的规定编制。

\*: 电路板组件包括印刷电路板及其构成的零部件，如电阻、电容、集成电路、连接器等。

O: 表示该有害物质在该部件所有均质材料中的含量均在 GB/T 26572规定的限量要求以下。

X: 表示该有害物质至少在该部件的某一均质材料中的含量超出GB/T 26572规定的限量要求。

上表中打“X”的部件，应功能需要，部分有害物质含量超出GB/T 26572规定的限量要求，但符合欧盟 RoHS法规要求 (属于豁免部分)。

备注：上表仅做为范例，实际标示时应依照各产品的实际部件及所含有害物质进行标示。



### 环保使用期限

此标识指期限 (十年)，电子电气产品中含有的有害物质在正常使用的条件下不会发生外泄或突变，电子电气产品用户使用该电子电气产品不会对环境造成严重污染或对其人身、财产造成严重损害的期限。

#### 《废弃电器电子产品回收处理管理条例》提示性说明

为了更好地关爱及保护地球，当用户不再需要此产品或产品寿命终止时，请遵守国家废弃电器电子产品回收处理相关法律法规，将其交给当地具有国家认可的回收处理资质的厂商进行回收处理，不当利用或者处置可能会对环境和人类健康造成影响。

警告：在居住环境中，运行此设备可能会造成无线电干扰。

警語：使用過度恐傷害視力。

注意事項：

(1) 使用30分鐘請休息10分鐘。

(2) 未滿2歲幼兒不看螢幕，2歲以上每天看螢幕不要超過1小時。

警告使用者：

此為甲類資訊技術設備，於居住環境中使用時，可能會造成射頻擾動，在此種情況下，使用者會被要求採取某些適當的對策。

警告：為避免電磁干擾，本產品不應安裝或使用於住宅環境。

### Turkey RoHS:

Türkiye Cumhuriyeti: EEE Yönetmeliğine Uygundur

### Ukraine RoHS:

Обладнання відповідає вимогам Технічного регламенту щодо обмеження використання деяких небезпечних речовин в електричному та електронному обладнанні, затвердженого постановою Кабінету Міністрів України від 10 березня 2017 р. № 139

### End-of-Life Disposal

Your new Public Information Display contains materials that can be recycled and reused. Specialized companies can recycle your product to increase the amount of reusable materials and to minimize the amount to be disposed of.

Please find out about the local regulations on how to dispose of your old display from your local Philips dealer.

(For customers in Canada and U.S.A.)

This product may contain lead and/or mercury. Dispose of in accordance to local-state and federal regulations. For additional information on recycling contact [www.eia.org](http://www.eia.org) (Consumer Education Initiative)

## Waste Electrical and Electronic Equipment-WEEE

### Attention users in European Union private households

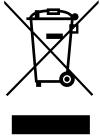

This marking on the product or on its packaging illustrates that, under European Directive 2012/19/EU governing used electrical and electronic appliances, this product may not be disposed of with normal household waste. You are responsible for disposal of this equipment through a designated waste electrical and electronic equipment collection. To determine the locations for dropping off such waste electrical and electronic, contact your local government office, the waste disposal organization that serves your household or the store at which you purchased the product.

### Attention users in United States:

Please dispose of according to all Local, State and Federal Laws. For the disposal or recycling information, contact: [www.mygreenelectronics.com](http://www.mygreenelectronics.com) or [www.eiae.org](http://www.eiae.org).

### End of Life Directives-Recycling



Your new Public Information Display contains several materials that can be recycled for new users.

Please dispose of according to all Local, State, and Federal laws.



ENERGY STAR is a program run by the U.S. Environmental Protection Agency (EPA) and U.S. Department of Energy (DOE) that promotes energy efficiency.

This product qualifies for ENERGY STAR in the "factory default" settings and this is the setting in which power savings will be achieved.

Changing the factory default picture settings or enabling other features will increase power consumption that could exceed the limits necessary to qualify for ENERGY STAR rating.

For more information on the ENERGY STAR program, refer to [energystar.gov](http://energystar.gov).

### Restriction on Hazardous Substances statement (India)

This product complies with the "E-Waste (Management) Rules, 2016" CHAPTER V, rule 16, sub-rule (1) . Whereas New Electrical and Electronic Equipment and their components or consumables or parts or spares do not contain Lead, Mercury, Cadmium, Hexavalent Chromium, polybrominated biphenyls and polybrominated diphenyl ethers beyond a maximum concentration value of 0.1% by weight in homogenous materials for lead, mercury, hexavalent chromium, polybrominated biphenyls and polybrominated diphenyl ethers and of 0.01% by weight in homogenous materials for cadmium. except of exemptions set in Schedule 2 of the Rule.

### E-Waste Declaration for India

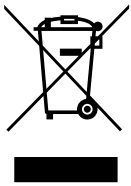

This symbol on the product or on its packaging indicates that this product must not be disposed of with your other household waste. Instead it is your responsibility to dispose of your waste equipment by handing it over to a designated collection point for the recycling of waste electrical and electronic equipment . The separate collection and recycling of your waste equipment at the time of disposal will help to conserve natural resources and ensure that it is recycled in a manner that protects human health and the environment. For more information about E -waste please visit <http://www.india.philips.com/about/sustainability/recycling/index.page> and to know where you can drop off your waste equipment for recycling in India please contact on below given contact details.

Helpline number: 1800-425-6396 (Monday to Saturday, 9 a.m. to 5:30 pm)

E-mail: [india.callcentre@tpv-tech.com](mailto:india.callcentre@tpv-tech.com)

## Batteries



For EU: The crossed-out wheeled bin implies that used batteries should not be put to the general household waste! There is a separate collection system for used batteries, to allow proper treatment and recycling in accordance with legislation.

Please contact your local authority for details on the collection and recycling schemes.

For Switzerland: The used battery is to be returned to the selling point.

For other non-EU countries: Please contact your local authority for correct method of disposal of the used battery. According to EU directive 2006/66/EC, the battery can't be disposed improperly. The battery shall be separated to collect by local service.



Após o uso, as pilhas e/ou baterias deverão ser entregues ao estabelecimento comercial ou rede de assistência técnica autorizada.

Information for EAC	
Month and year of manufacturing	please refer information in Rating label.
Name and location of manufacturer	ООО "Профтехника" Адрес: 3-й Проезд Марьиной рощи, 40/1 офис 1. Москва, 127018, Россия
Importer and information	Наименование организации: ООО "Профтехника" Адрес: 3-й Проезд Марьиной рощи, 40/1 офис 1. Москва, 127018, Россия Контактное лицо: Наталья Астафьева, +7 495 640 20 20 <a href="mailto:nat@profdisplays.ru">nat@profdisplays.ru</a>

## 2. Unpacking and Installation

### 2.1. Unpacking

- This product is packed in a carton, together with the standard accessories.
- Any other optional accessories will be packed separately.
- As this product is high and heavy, the operation of moving the device is recommended to be performed by two technicians.
- After opening the carton, ensure that the contents are complete and in good condition.

#### ■ Before Unpacking

- Please read and fully understand unpacking notice before installation.
- Please check the packaging for any abnormalities, such as creaking, dents, etc.
- Please do necessary inspection before you move the display out of the carton.
- Always have an experienced technician install the display to prevent any damage.

#### ■ Notice

- For display with handles:
  - Take the display out of the carton box by two or four adults with both hands.
  - Hold onto the handles when moving the display.

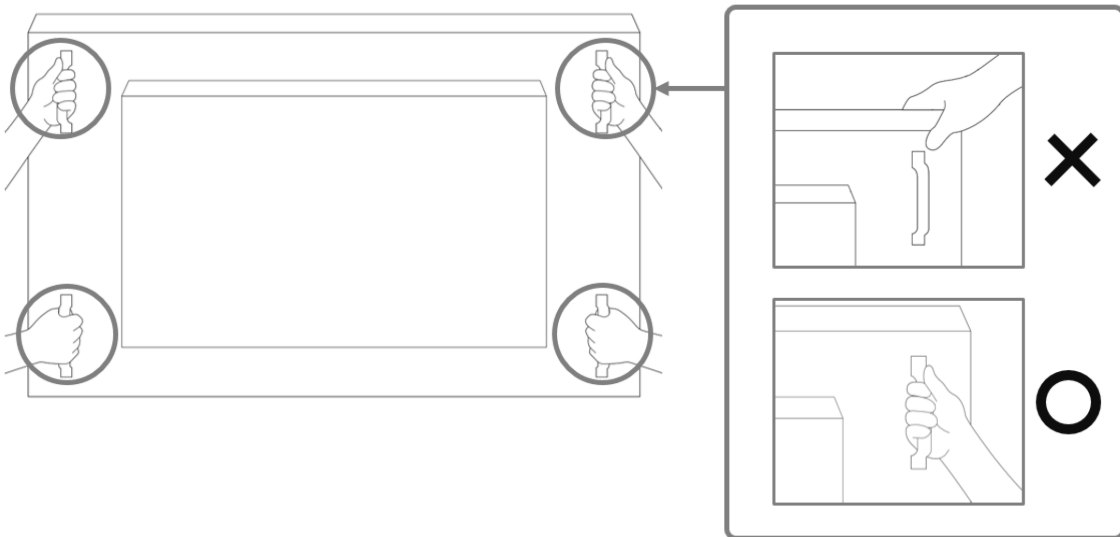

- Please keep the display upright when moving it.

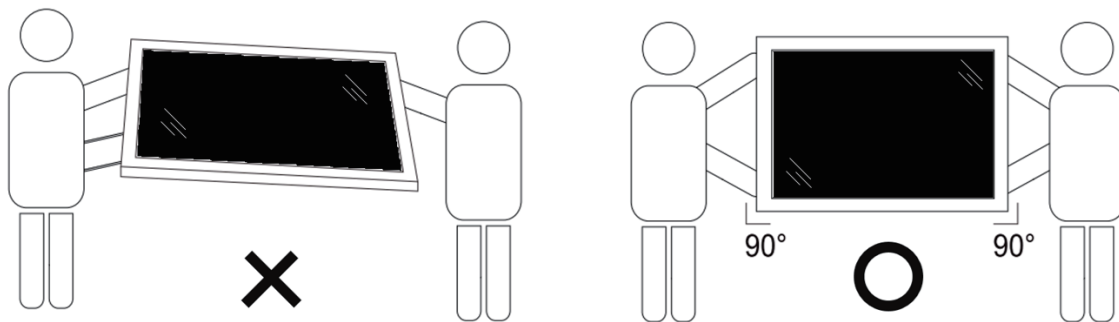



- Place the display vertically and its weight should spread evenly on the surface.

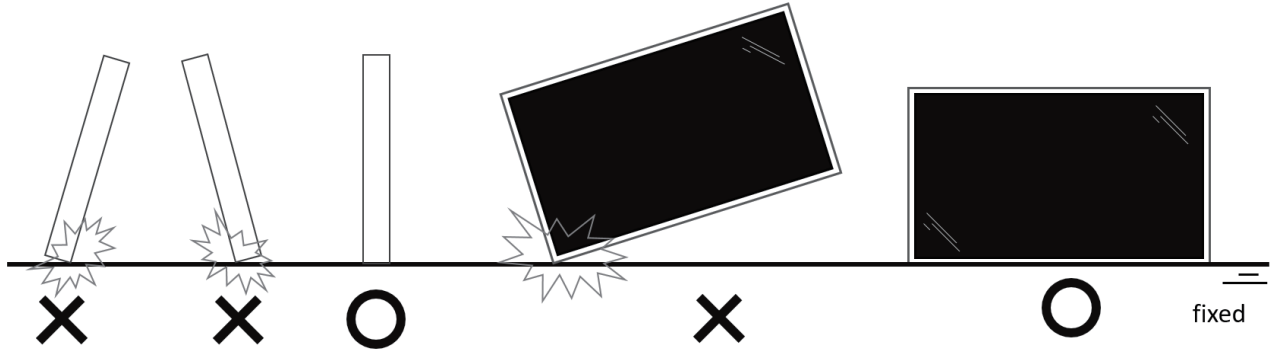

- Keep the display upright, without bending or twisting it while moving.



## ■ Unpacking Process

1. Remove the tape.

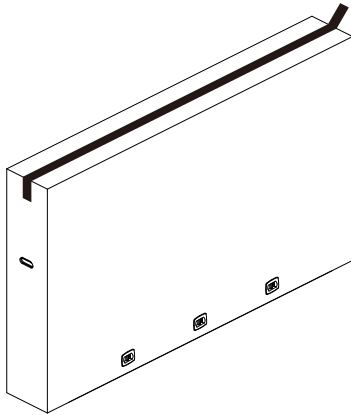

2. Remove all accessories and top cushion from the top opening of the packaging.

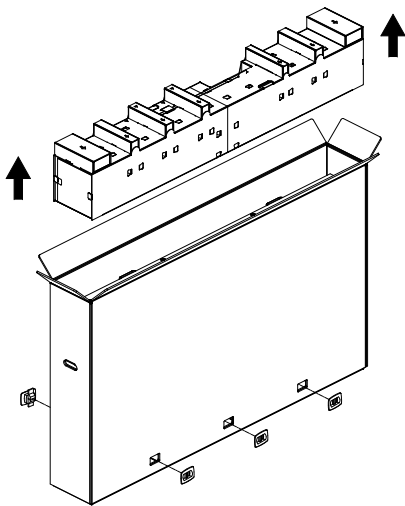

3. Discard the cardboard and open the packing bag.

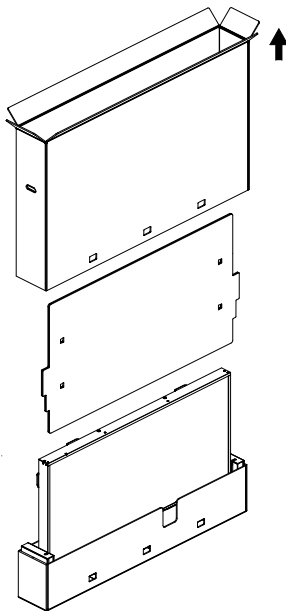

4. Install the wall mount kit (\*) while the display is still in the bottom cushion. (\* need to purchase separately)

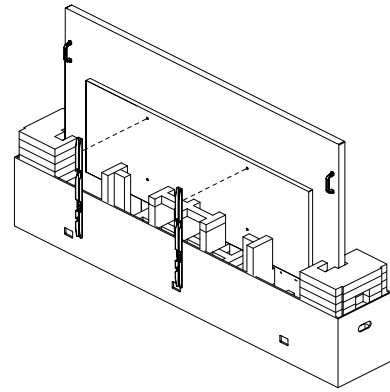

5. Two people on the sides should hold the top handles from the back of the display, while two others help hold the display from the bottom.

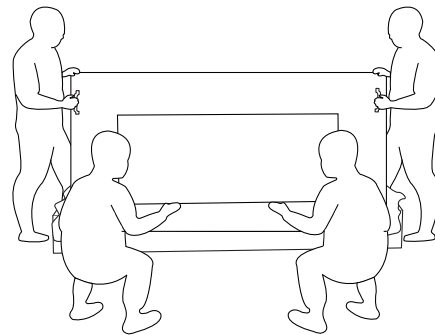

6. Carefully move the display until the bottom handles are out of the box. Two people on the sides should hold the 4 handles, while two others stand at the front and back of the display to support the bottom.

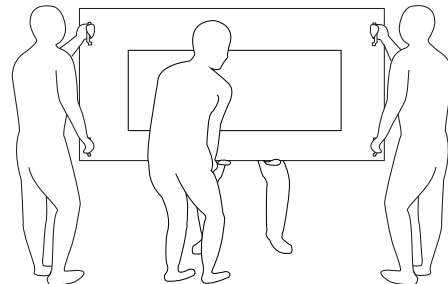

7. The person who was initially at the back of the display should move to the front, so that all four people can mount the display onto the wall.

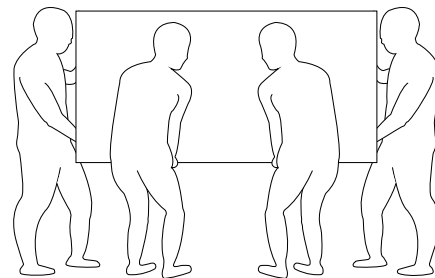

## 2.2. Package Contents

Please verify that you received the following items with your package content:

- LCD display
- Quick start guide
- Remote Control and AAA Batteries
- Power cord
- RS232 cable
- RS232 daisy chain cable
- IR sensor cable
- USB cover
- AC Switch cover
- Cable Clip x 2PCS
- Philips logo plate
- CRD22 Wi-Fi module

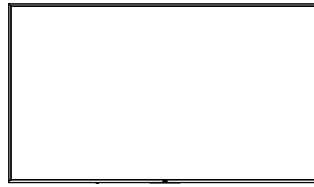

LCD display

\* The supplied power cord varies depending on destination.



Remote Control and AAA Batteries



Quick start guide



Power Cord

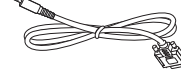

RS232 Cable

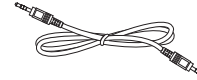

RS232 Daisy Chain Cable



IR Sensor Cable

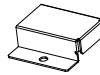

AC Switch Cover



USB Cover



Cable Clip x 2PCS



Philips logo plate

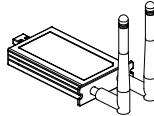

CRD22 Wi-Fi module

\* Differences according to regions.

\* Display design and accessories may differ from those illustrated above.

### NOTES:

- For all other regions, apply a power cord that conforms to the AC voltage of the power socket and has been approved by and complies with the safety regulations of the particular country (Type H05W-F, 2G or 3G, 0.75 or 1 mm<sup>2</sup> should be used).
- Keep the packaging materials appropriately after unpacking the product.

## 2.3. Installation Notes

- Only use the power cable provided with this product. If an extension cord is required, please consult your service agent.
- The product should be installed on a flat surface, or the product may tip over. Leave a space between the rear of the product and the wall for proper ventilation. Do not install the product in a kitchen, bathroom or a place exposed to moisture, failure to do so may shorten the life of the internal parts.
- Do not install the product where it is 3000m and higher in altitude. Failure to do so may result in malfunctions.

## 2.4. Mounting on a Wall

To mount this display on a wall, a standard wall-mounting kit (commercially available) is required. It is recommended that you use a mounting interface that complies with TUV-GS and /or UL1678 standard in North America.

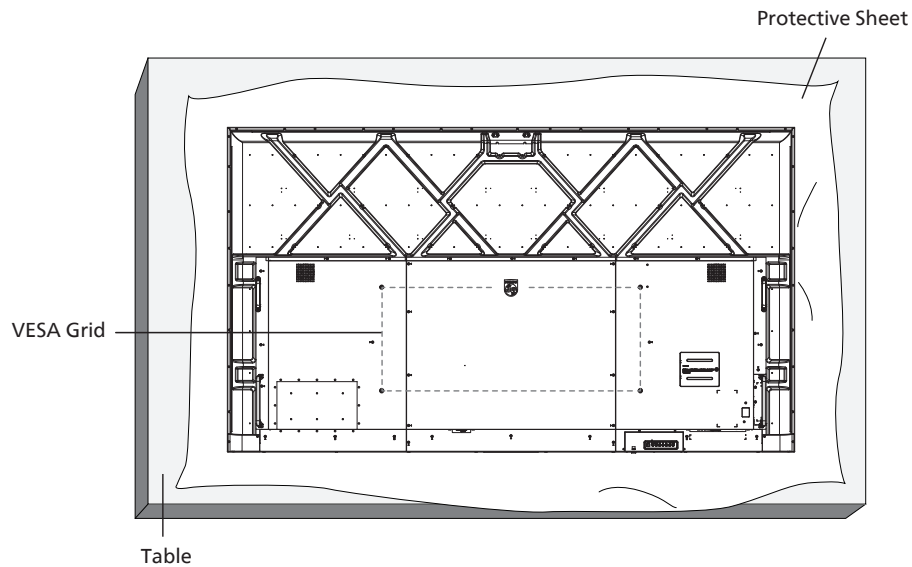

1. Prepare a flat and horizontal surface that is larger than the display and spread a thick protective sheet on it to facilitate your operation without scratching the screen.
2. Ensure you have all accessories for all types of mounting (wall mount, ceiling mount, table stand, etc).
3. Follow the instructions that came with the base mounting kit. Failure to follow the correct mounting procedures could result in damage to the equipment, or injury to the user or installer. The product warranty does not cover the damage caused by improper installation.
4. For the wall-mounting kit, use the M8 mounting screws (with a length 15 mm longer than the thickness of the mounting bracket) and tighten them securely.

### 2.4.1. VESA Grid

98BDL4650D	1000(H) x 400(V) mm
------------	---------------------

#### Caution:

To prevent the display from falling:

- For wall or ceiling mounting, we recommend that you install the display with metal brackets which are commercially available. For detailed instructions about the installation, refer to the guide provided with the bracket.
- To prevent the display from falling in case of earthquake or other natural disaster, please consult the manufacturer of the bracket for the mounting location.
- As this product is high and heavy, the installation of this product is recommended to be performed by four technicians.

#### Required space for ventilation

Leave a space of 100 mm at the top, rear, right and left of the display for ventilation.

Note: We recommend you contact a professional technician when installing the display on a wall. We are not responsible for any damage to the product if the installation is not performed by a professional technician.

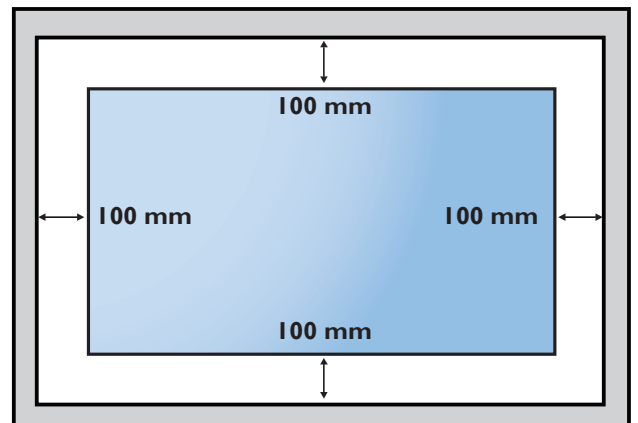

## 2.5. Mounting in Portrait Orientation

This display can be installed in portrait orientation.

Rotate the display 90 degrees counterclockwise. The "PHILIPS" logo should be on the right side when facing the display.

NOTE: The working hour in portrait mode is 24 hours per day.



### 2.5.1. How to remove the logo plate

1. Prepare a piece of paper with a cutting area of logo as a protector to prevent the front bezel from scratching.
2. Use a knife and carefully remove the logo sticker with the paper placing beneath.
3. Tear off the logo sticker.

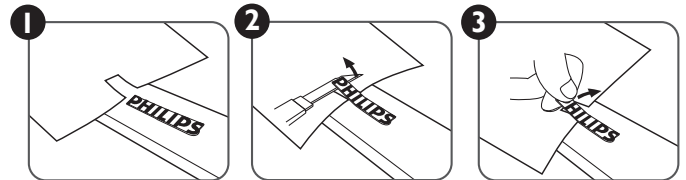

NOTE: We recommend you contact a professional technician when installing the display on a wall. We are not responsible for any damage to the product if the installation is not performed by a professional technician.

### 3. Parts and Functions

#### 3.1. Control Panel

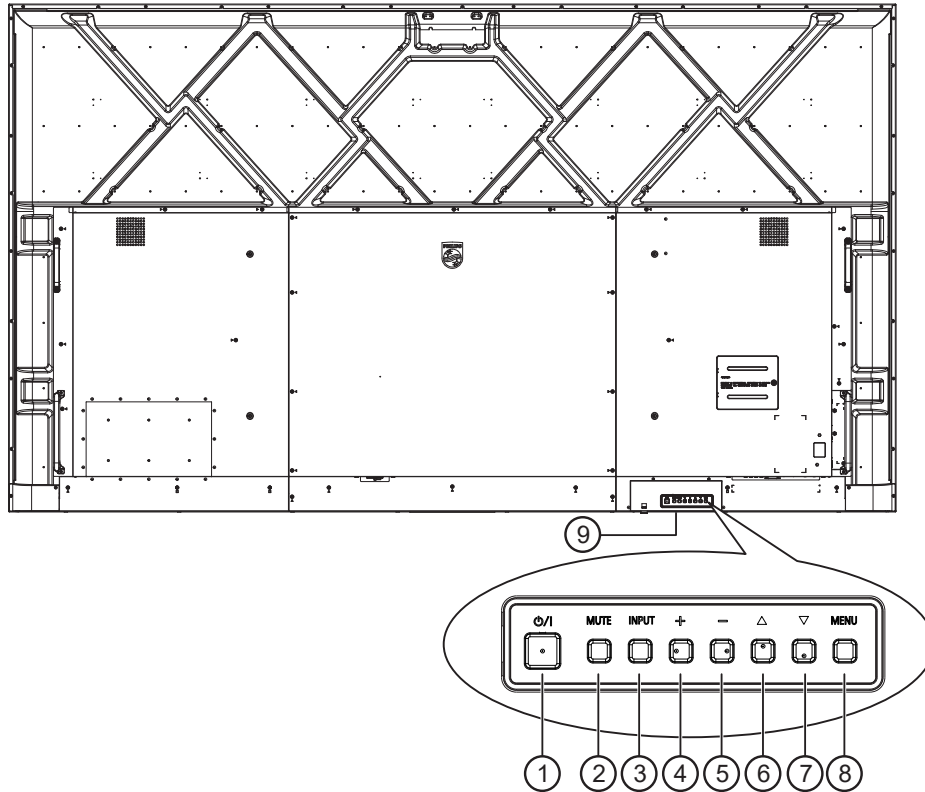

① [⏻] button

Press this button to turn the display on or put it in standby mode.

② [MUTE] button

Press this button to mute or unmute the sound.

③ [INPUT] button

Choose the input source.  
Confirm a selection in the OSD menu.

④ [+] button

Increase the adjustment while OSD menu is on, or increase the audio output level while OSD menu is off.

⑤ [-] button

Decrease the adjustment while OSD menu is on, or decrease the audio output level while OSD menu is off.

⑥ [▲] button

Move the selected item one level up while the OSD menu is On.

⑦ [▼] button

Move the selected item one level down while the OSD menu is On.

⑧ [MENU] button

Return to the previous menu while the OSD menu is On. This button can also be used to activate the OSD menu when the OSD menu is Off.

⑨ Remote control sensor and power status indicator

- Receives command signals from the remote control.
- Indicates the operating status of the display:
  - Lights green when the display is turned on.
  - Lights red when the display is in standby mode.
  - Lights amber when the display enters APM mode.
  - When {SCHEDULE} is enabled, the light blinks green and red.
  - If the light blinks red, it indicates that a failure has been detected.
  - Lights off when the main power of the display is turned off.

## 3.2. Input/Output Terminals

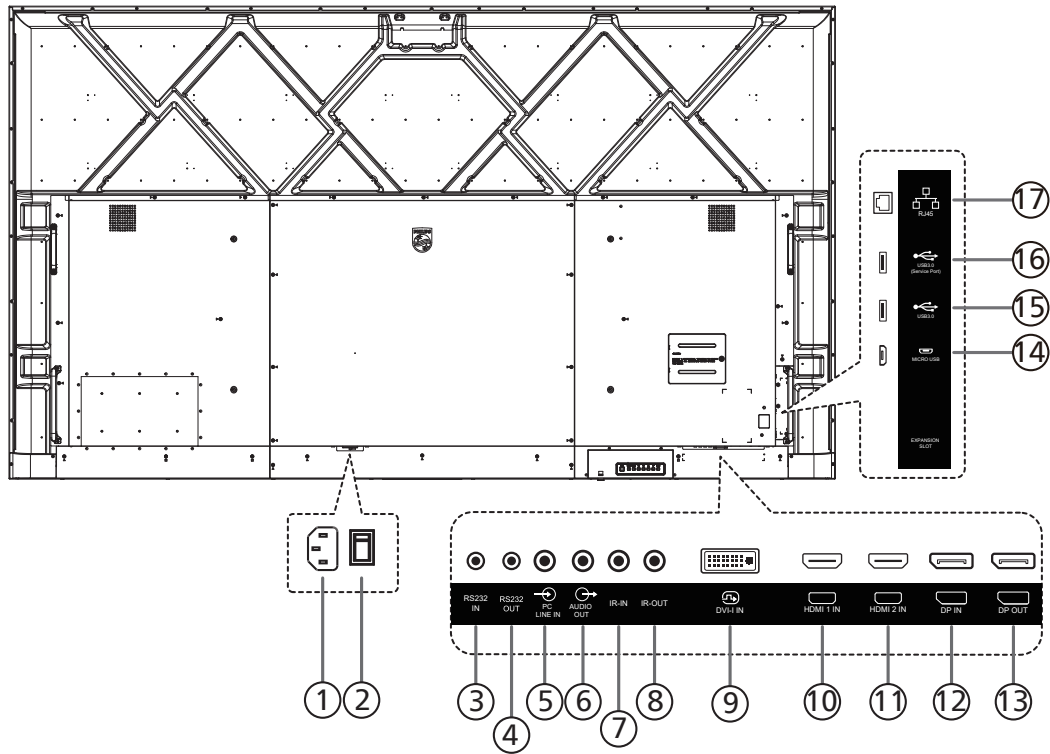

① **AC IN**

AC power input from the wall outlet.

② **MAIN POWER SWITCH**

Switch the main power between On and Off.

③ **RS232 IN** / ④ **RS232 OUT**

RS232 network input / output for the loop-through function.

⑤ **PC LINE IN**

Audio input for VGA source (3.5mm stereo phone).

⑥ **AUDIO OUT**

Audio output to external AV device.

⑦ **IR IN** / ⑧ **IR OUT**

IR signal input / output for the loop-through function.

**NOTES:**

- This display's remote control sensor will stop working if the jack [IR IN] is connected.
- To remotely control your A/V device via this display, refer to page 28 for IR Pass Through connection.

⑨ **DVI-I IN**

DVI-I video input. VGA video input.

⑩ **HDMI1 IN** / ⑪ **HDMI2 IN**

HDMI video/audio input.

⑫ **DisplayPort IN** / ⑬ **DisplayPort OUT**

DisplayPort video input / output.

⑭ **MICRO USB**

Support ADB data transmission, OTG is not supported.

⑮ **USB 3.0** / ⑯ **USB 3.0**

Connect to a USB storage device.

⑰ **RJ-45**

LAN control function for the use of remote control signal from control center.

### 3.3. Remote Control

#### 3.3.1. General functions

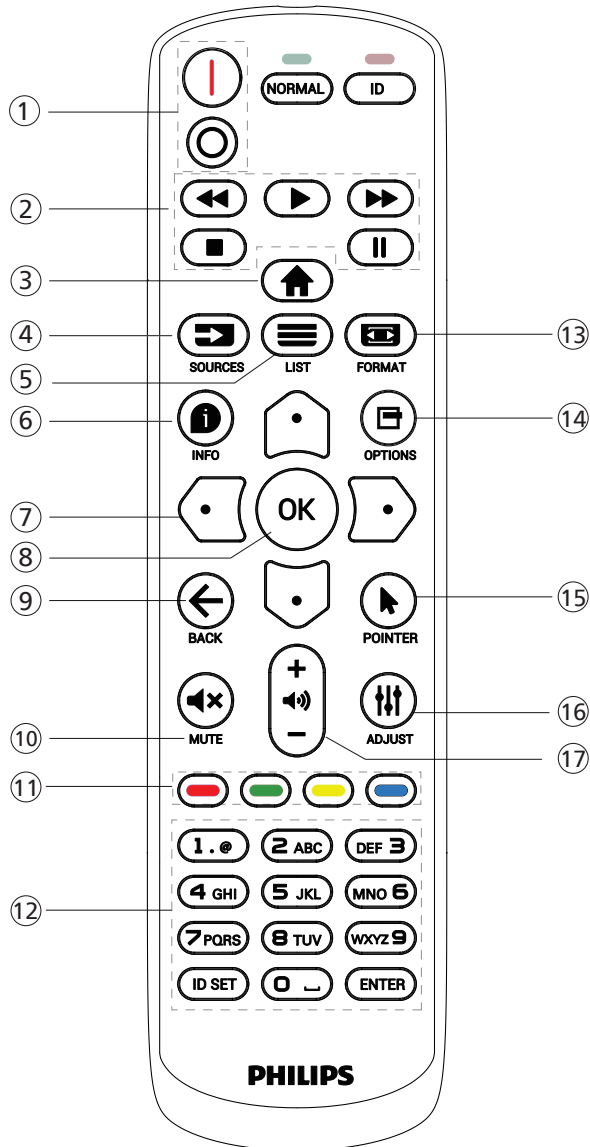

#### ① [I/O] POWER button

[I] Turn the power On.  
[O] Turn the power Off.

#### ② [PLAY] buttons

Control playback of media files.(for Media Input only)  
Freeze feature  
Pause: hotkey for freezing all inputs content.  
Play: hotkey for unfreezing all input content.

#### ③ [HOME] HOME button

Root Menu: Access the OSD menu.  
Others: Exit the OSD menu.

#### ④ [SOURCE] SOURCE button

Root Menu: Choose input source.

#### ⑤ [LIST] LIST button

Reserved.

#### ⑥ [INFO] INFO button

Show Information OSD.

#### ⑦ NAVIGATION buttons



Root Menu: Go to the OSD of Smart picture.  
Main Menu: Move the selected item up to make adjustment.

IR Daisy Chain Menu: Increase the controlled Group ID number.



Root Menu: Go to the OSD of Audio source.

Main Menu: Move the selected item down to make adjustment.

IR Daisy Chain Menu: Decrease the controlled Group ID number.



Volume Menu: Decrease the volume.



Main Menu: Go to the next level of menu or set selected option.

Source Menu: Go to the selected source.

Volume Menu: Increase the volume.

#### ⑧ [OK] button

Root Menu: Go to the OSD of IR daisy chain in Primary/ Secondary mode.

Main Menu: Confirm an entry or selection.

#### ⑨ [←] BACK button

Return to the previous page or exit from the previous function.

#### ⑩ [MUTE] MUTE button

Mute or unmute the sound.

#### ⑪ [COLOR] COLOR buttons

[Blue] Hot key to turn on and off backlight.  
[Green] Hot key for Window selection function.  
[Red] Hot key for IR daisy chain OSD.

#### ⑫ [Number/ ID SET/ ENTER] button

Press to set the display ID. Refer to 3.3.2. ID Remote Control for more details.

#### ⑬ [FORMAT] FORMAT button

Select image zoom mode from Full, 4:3, 1:1, 16:9, 21:9 or Custom.

#### ⑭ [OPTIONS] OPTIONS button

Reserved.

#### ⑮ [POINTER] POINTER button

Reserved.

#### ⑯ [ADJUST] ADJUST button

Go to the OSD of Auto Adjust (for VGA only).

#### ⑰ [VOLUME] VOLUME button

Adjust the volume.



### 3.3.2. ID Remote Control

Set remote control ID number when using several displays.

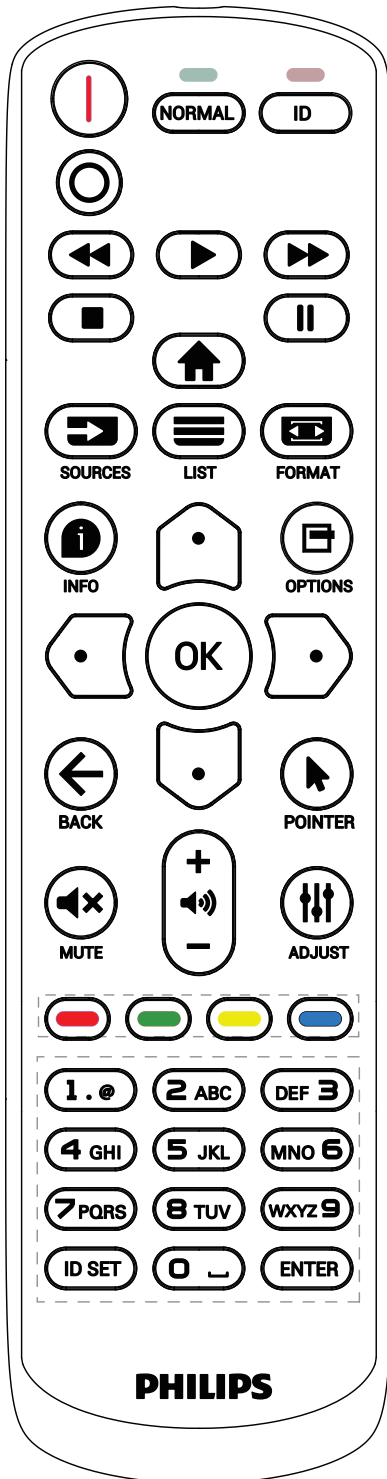

Press the [ID] button and the red LED blinks twice.

1. Press [ID SET] button for more than 1 second to enter the ID Mode. The red LED lights up.  
Press the [ID SET] button again will exit the ID Mode. The red LED lights off.

Press the digit numbers [0] ~ [9] to select the display to be controlled.

For example: press [0] and [1] for display No.1, press [1] and [1] for display No.11.

The numbers available are [01] ~ [255].

2. If no button is pressed within 10 seconds, it will exit from the ID mode.
3. If a wrong button is pressed, wait for 1 second until the red LED lights off and then turns on again, then press the correct digits.
4. Press [ENTER] button to confirm your selection. The red LED blinks twice and then lights off.

#### NOTE:

- Press [NORMAL] button. The green LED blinks twice, indicating that the display is under normal operation.
- It is necessary to set up the ID number for each display before selecting its ID number.

### 3.3.3. Remote Control buttons on Android source

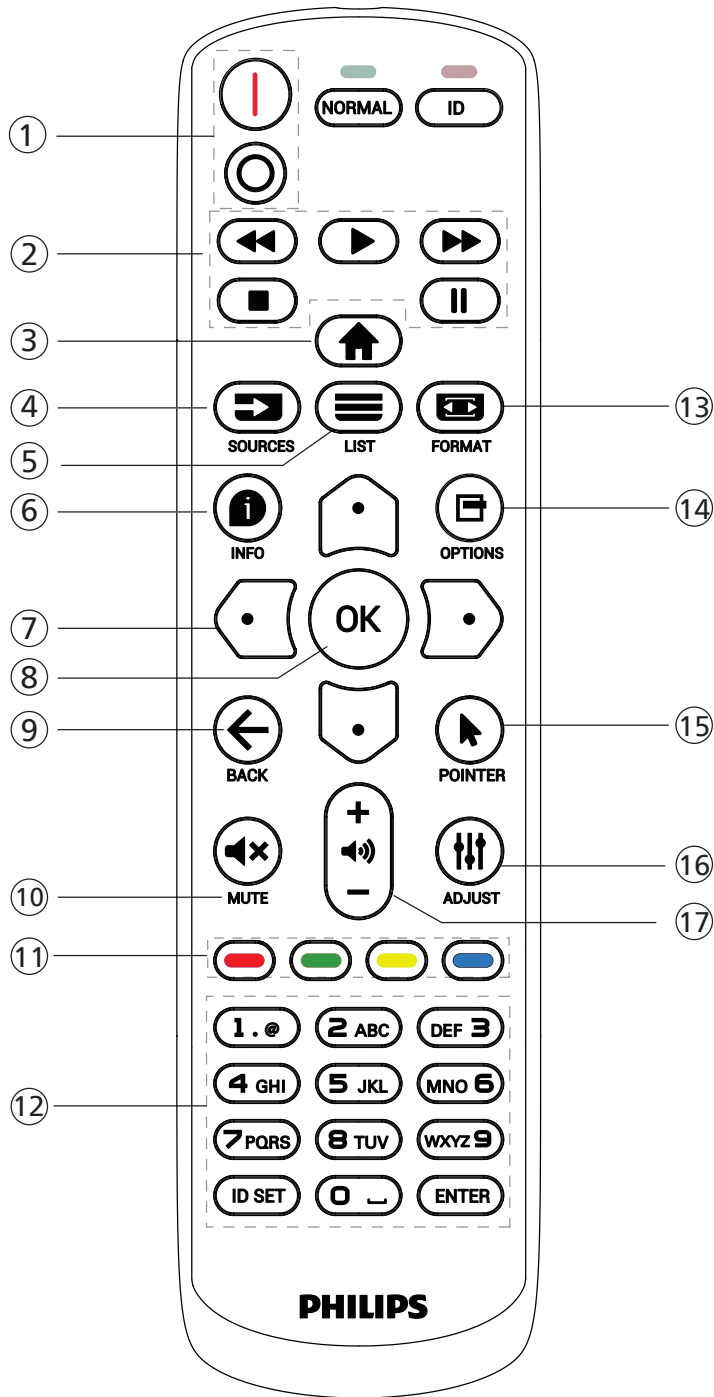

- ① [I/O] **POWER button**  
 [I] Turn the power On.  
 [O] Turn the power Off.

- ② [PLAY] buttons  
 Control playback of media files.  
 ▶ Play the media files directly.  
 [||] Pause playing.  
 [■] Stop playing media files.  
 After stopping playing by pressing [■] button, press ▶ again, playback will be started from the beginning of the file.
- ③ [HOME] button  
 Access OSD menu.
- ④ [SOURCE] button  
 Choose input source.
- ⑤ [LIST] button  
 1. In the content of the web page, move the focus up to the next selectable items.  
 2. Move the focus up to the next control or widget such as buttons.
- ⑥ [INFO] button  
 Display information about the current input signal.  
 1. Media Player -> Compose -> edit or add a new playlist -> choose any media files -> press [INFO] to show the information of the selected media file.
- ⑦ [HOME]/[UP]/[LEFT]/[RIGHT] NAVIGATION buttons  
 1. Navigate through the menus and select an item.  
 2. In the content of the web page, these buttons are for controlling the scroll bar of the screen. Press [HOME] or [UP] to move the vertical scroll bar up or down. Press [LEFT] or [RIGHT] to move the horizontal scroll bar left or right.  
 3. For PDF files, when zoom in/out has been performed, press [HOME], [UP], [LEFT] or [RIGHT] to adjust the position of the screen. When zoom in/out has been not performed, press [RIGHT] to go to the next page, press [LEFT] to go to the previous page.
- ⑧ [OK] button  
 Confirm an entry or selection.
- ⑨ [BACK] button  
 Return to the previous page or exit from the previous function.
- ⑩ [MUTE] button  
 Press to turn the mute function on/off.
- ⑪ [RED] [GREEN] [YELLOW] [BLUE] COLOR buttons  
 Reserved.
- ⑫ [Number/ ID SET/ ENTER] button  
 1. No functions for ID SET and ENTER on Android source.  
 2. For PDF file, enter the page number by pressing number buttons and then press [OK] button to jump to the specific page.
- ⑬ [FORMAT] button  
 Change picture format.

---

⑭ [☰] **OPTIONS button**

Open toolbox in Media Player or PDF Player.

1. Media Player or PDF Player -> Compose -> Edit or add a new playlist -> press [☰] to open toolbox. The toolbox will slide in from the left side of the screen.

⑮ [☞] **POINTER button**

Reserved.

⑯ [⌵] **ADJUST button**

1. In the content of the web page, move the focus down to the next selectable items.

2. Move the focus down to the next control or widget such as buttons.

⑰ [−] [+] **VOLUME button**

Adjust volume level.

### 3.4. Inserting the batteries in the remote control

The remote control is powered by two 1.5V AAA batteries.

To install or replace the batteries:

1. Press and then slide the cover to open it.
2. Insert the batteries with the correct polarity (+) and (-).
3. Replace the cover.

#### Caution:

Incorrect use of batteries may cause leakage or explosion. Be sure to follow the instructions below:

- Insert "AAA" batteries with the correct polarity (+ and -).
- Do not mix battery types.
- Do not use a new battery with a used one together. Otherwise, it may cause leakage or shorten the life of the batteries.
- Remove the dead batteries immediately to avoid battery leakage in the battery compartment. Do not touch exposed battery acid, as it may cause injury to your skin.
- Disposal of a battery into fire or a hot oven, or mechanically crushing or cutting of a battery, that can result in an explosion; leaving a battery in an extremely high temperature surrounding environment that can result in an explosion or the leakage of flammable liquid or gas; and a battery subjected to extremely low air pressure that may result in an explosion or the leakage of flammable liquid or gas.

Note: Remove the batteries from the battery compartment when not using for an extended period of time.

### 3.5. Handling the remote control

- Do not drop or apply shock to the remote control.
- Do not allow any liquid to get inside the remote control. If water has entered the remote control, wipe the remote control with a dry cloth immediately.
- Do not place the remote control near heat and steam sources.
- Do not attempt to disassemble the remote control, unless you need to place batteries in the remote control.

### 3.6. Operating range of the remote control

Point the top front of the remote control at the remote sensor on the display when you press the buttons.

Use the remote control within a distance of less than 4m/16ft from the display's sensor, and a horizontal and vertical angle of less than 20°.

Note:

- The remote control may not function properly when the remote control sensor on the display is under direct sunlight or strong illumination, or when an obstacle blocks the signal transmission.
- Use an IR sensor cable for better performance of the remote control. (Refer to 4.5. IR connection for details)
- Pull down the lens to have better remote control performance and easy to observe the light information of power status.
- Push up the lens if need to move the display.
- Pull/Push the lens until hearing the click sound.

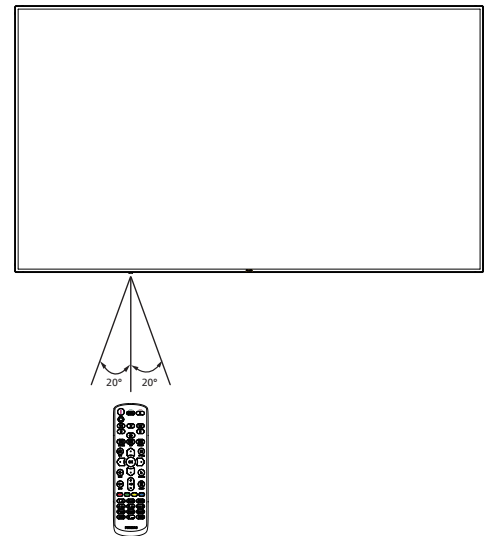
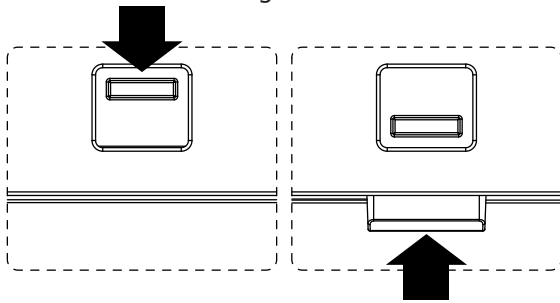

### 3.7. USB Cover

- Use the USB cover and screws to cover the USB stick
1. Plugin the USB device.
  2. Use the screw provided to fix the USB cover.

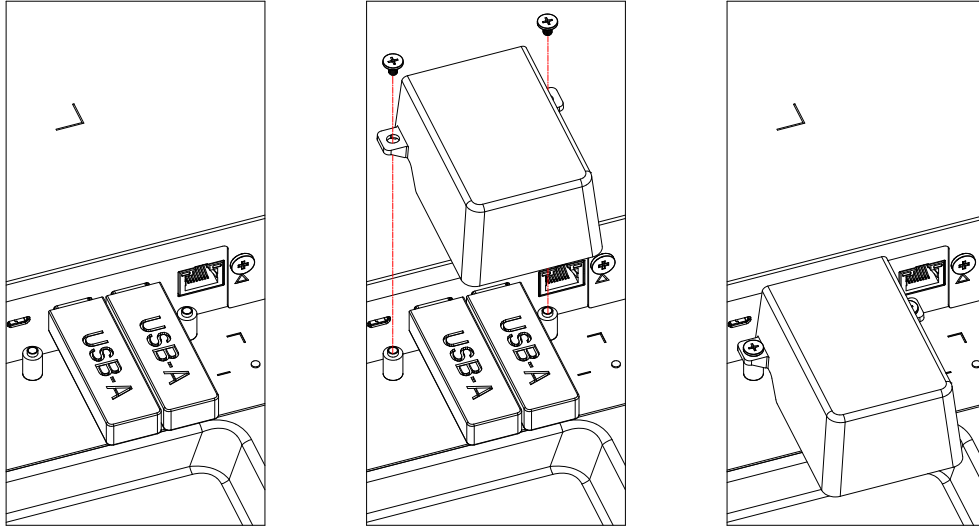

- Maximum suitable size for the USB stick:  
USB: 20(W)x10(H)x60(L) mm

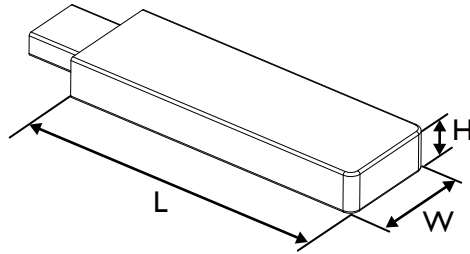

### 3.8. AC Switch Cover

Use AC Switch Cover to cover the AC switch.

1. Install the AC Switch Cover.
2. Fix the AC switch cover with the screw from the accessory kit.

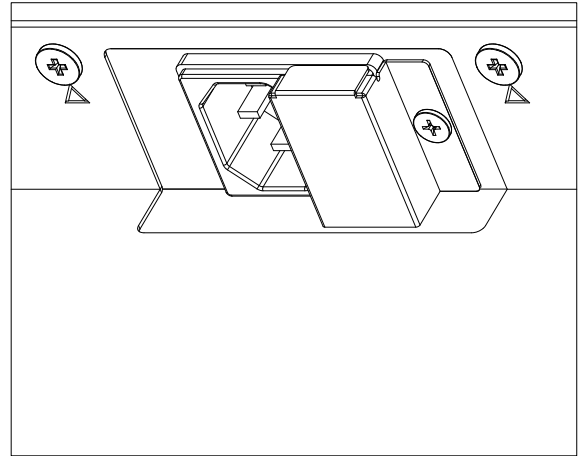
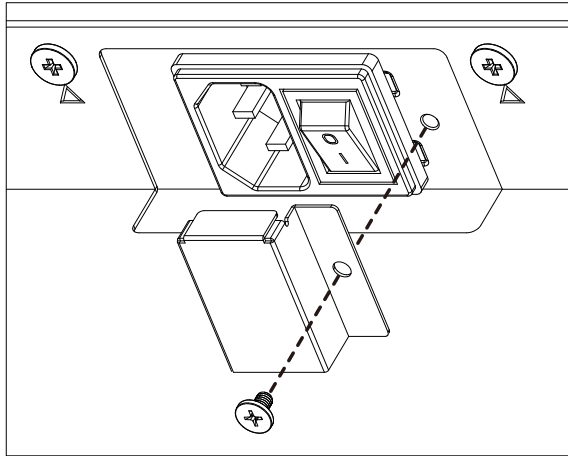

### 3.9. Installing the 4G module

1. Please consult a professional technician to install the 4G module.
2. Power off the display.
3. Loosen the screw on the service cover to take the service cover out. The 4G board is on the back side of the service cover. Flip over the service cover and ensure that the 4G cables are attached firmly to the 4G board. Careless operation may damage the 4G board.
4. Install the 4G module to the 4G board with two M2 screws.
5. Move the antenna from 4G board (position A) to 4G module (position B) as shown in diagram 3.
6. Install the service cover back to the display.

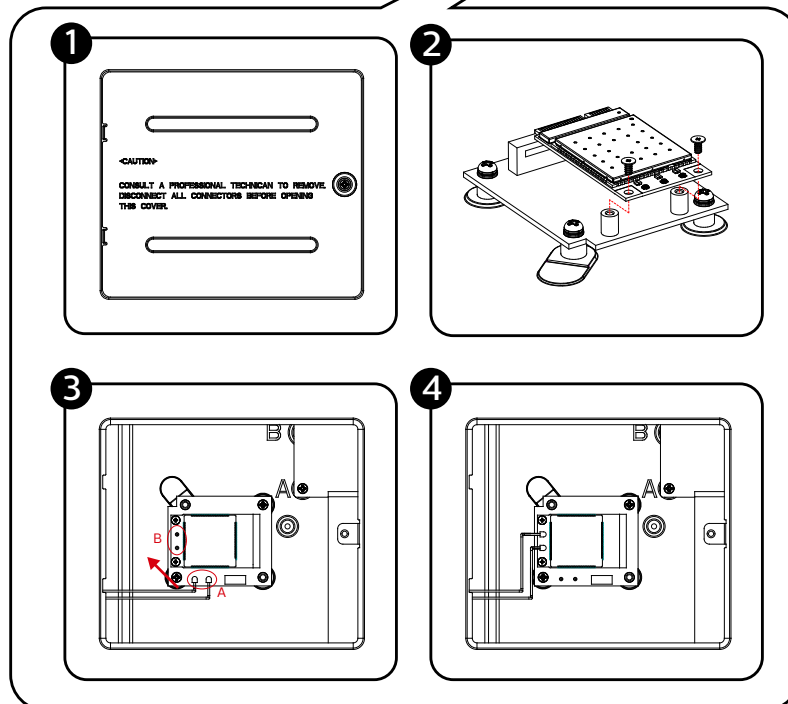
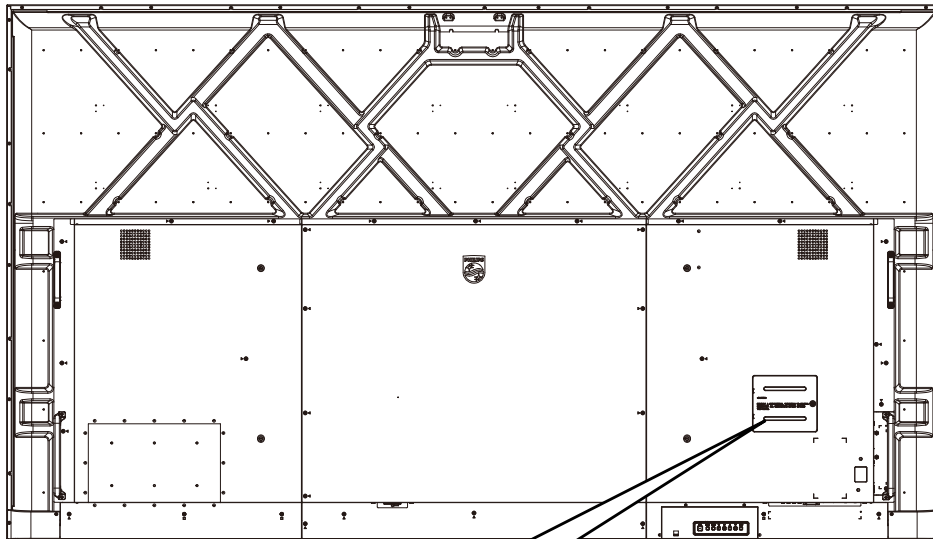

## 4. Connecting External Equipment

### 4.1. Connecting External Equipment (Multimedia Player)

#### 4.1.1. Using HDMI video input

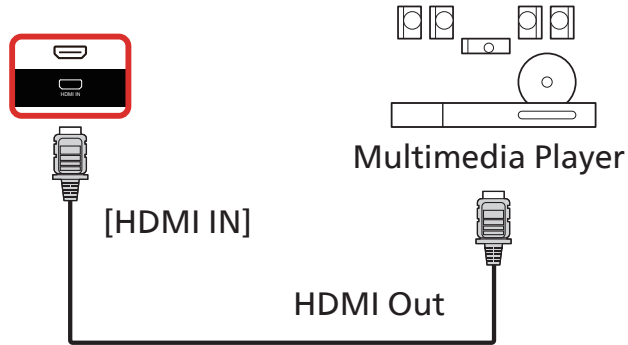

### 4.2. Connecting a PC

#### 4.2.1. Using DVI input



#### 4.2.2. Using HDMI input

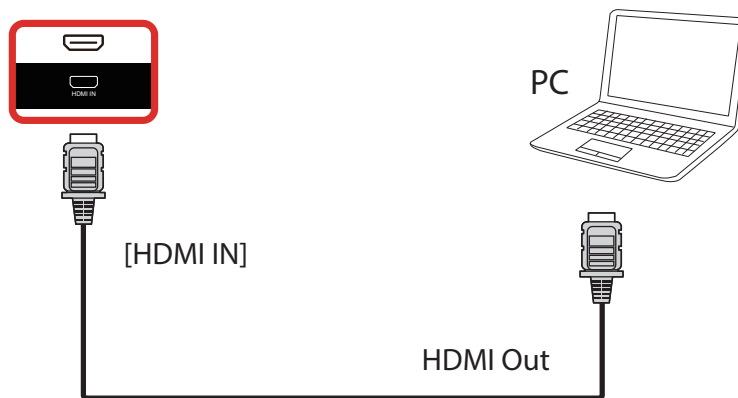



### 4.2.3. Using DP input

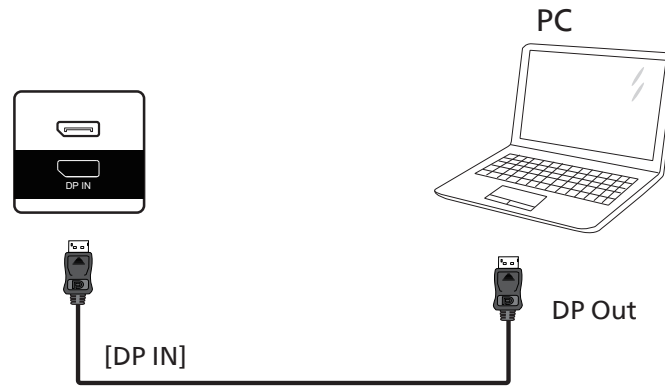

## 4.3. Connecting Audio Equipment

### 4.3.1. Connecting an external audio device

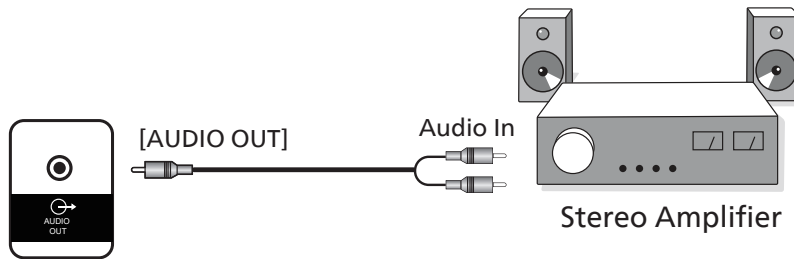

## 4.4. Connecting Multiple Displays in a Daisy-chain Configuration

You can interconnect multiple displays to create a daisy-chain configuration for applications such as a menu board.

### 4.4.1. Display control connection

Connect the [RS232 OUT] connector of DISPLAY 1 to the [RS232 IN] connector of DISPLAY 2.

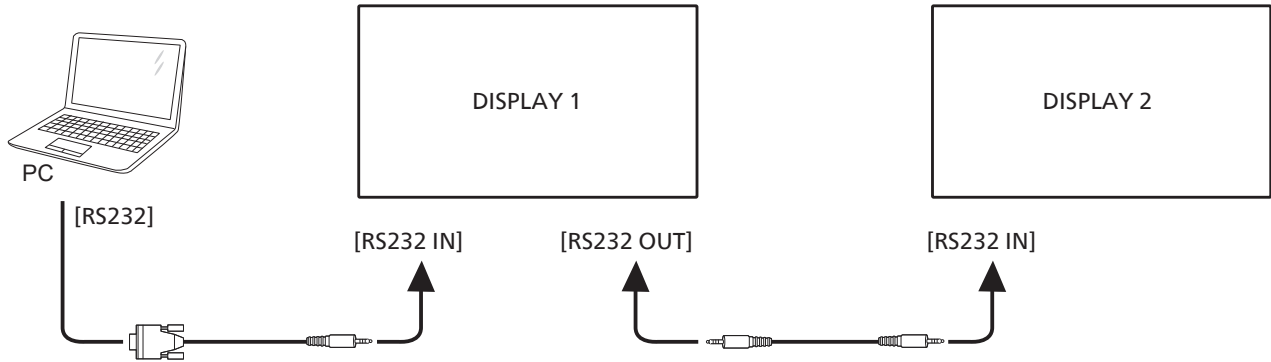

## 4.5. IR connection

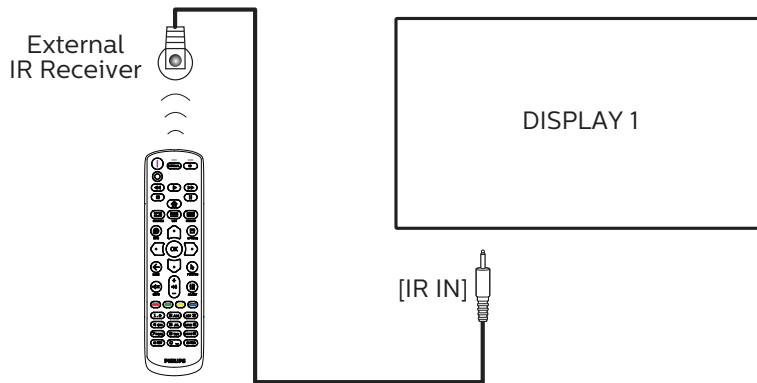

NOTE:

This display's remote control sensor will stop working if the [IR IN] is connected.

## 4.6. IR Pass-through Connection

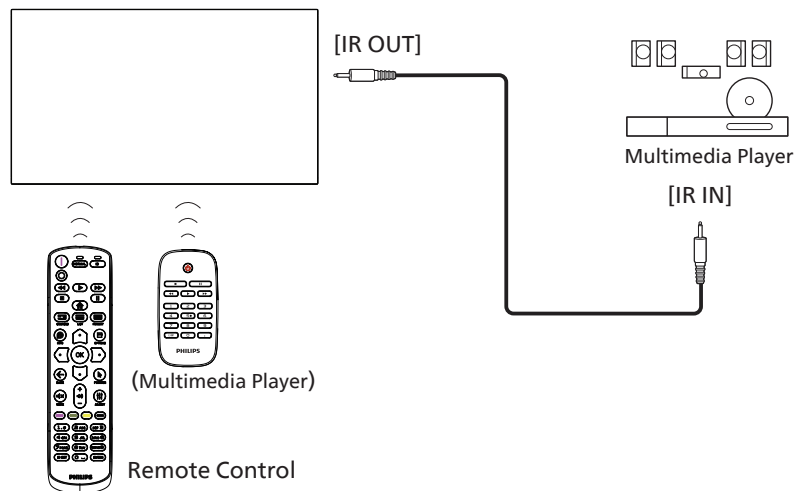

## 4.7. Wire-connecting to Network

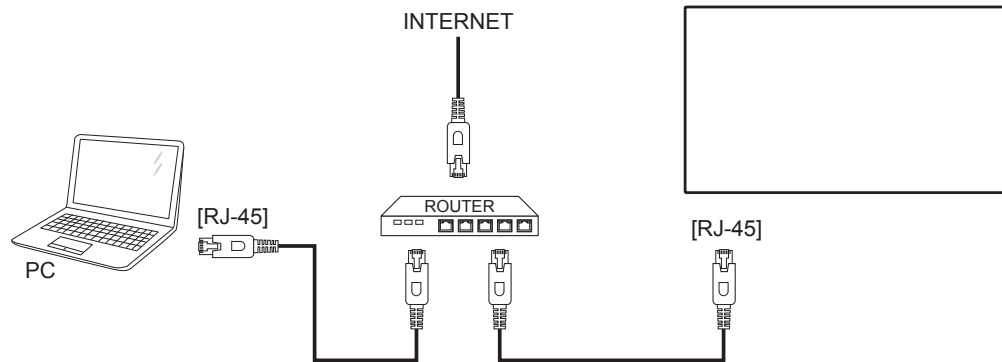

### Network Settings:

1. Switch the router on and enable its DHCP setting.
  2. Connect the router to this display with an Ethernet cable.
  3. Press [**HOME**] HOME button on the remote control, then select **Setup**.
  4. Select **Connect to network**, then press [**OK**] button.
  5. Wait until this display finds the network connection.
  6. If the "End User License Agreement" window prompts, accept the agreement.
- NOTE: Connecting with a shielded CAT-5 Ethernet cable to comply with the EMC directive.

## 5. Operation

**NOTE:** The control button described in this section is mainly on the remote control unless specified otherwise.

### 5.1. Watch the Connected Video Source

1. Press the [SOURCE] button.
2. Press [HOME] or [INFO] button to select a device, then press [OK] button.

### 5.2. Change Picture Format

You can change the picture format to suit the video source. Each video source has its available picture formats.

The available picture formats depend on the video source:

1. Press [FORMAT] button to select a picture format.
  - PC mode: {Full} / {4:3} / {1:1} / {16:9} / {21:9} / {Custom}.
  - Video mode: {Full} / {4:3} / {1:1} / {16:9} / {21:9} / {Custom}.

### 5.3. Overview

1. Android PD launcher:
  - Android PD launcher is a black page as shown below:

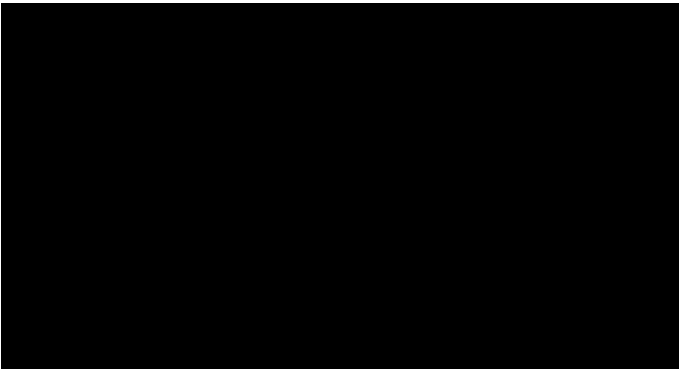

- Exit the App by pressing the "Back" key and the screen will enter Android PD launcher.
- When you return to Android PD launcher, a hint image will be prompted on the screen for 5~10 seconds.
- The hint image notifies you that you can press source key to change source.

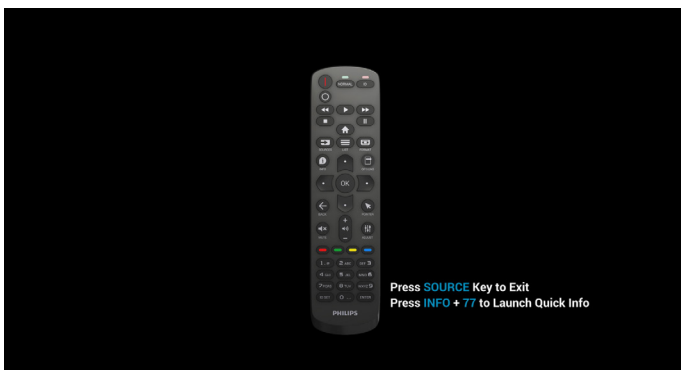

### 2. Admin mode:

- Press "Home + 1888" to enter the Admin mode. Please make sure that you see the Home OSD menu after "Home" is pressed, and then press 1888 in sequence. Two continuous "Home" keys will not be a valid hotkey.
- The Admin mode consists of the following Apps: "Settings", "Apps", "Network" "Storage" and "Help".
- When leaving from the Admin mode, the system will return to last source.

Settings: go to Settings page.

Applications: show all apps.

Network: set Wi-Fi, Ethernet and Mobile network (optional).

Storage: go to Storage page.

Help: display QR code to get help.

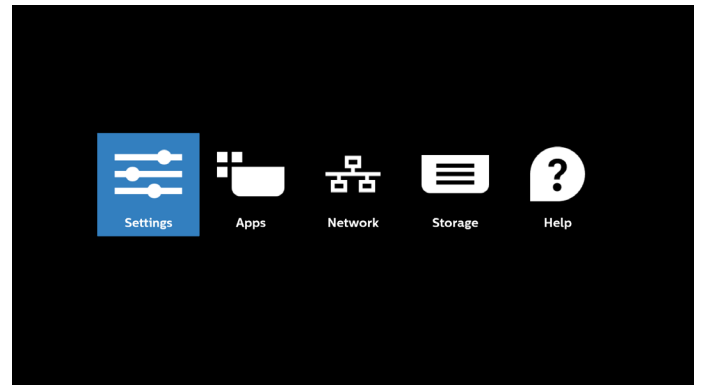

### 1) Settings page:

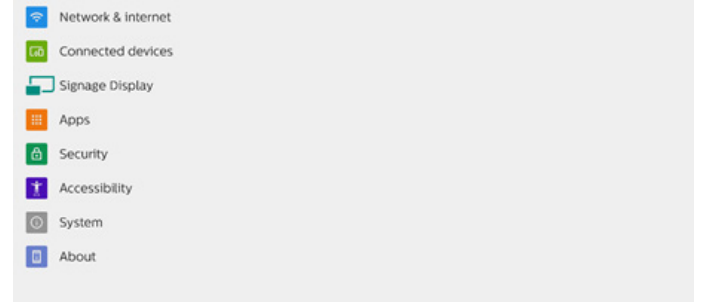

### 2) Application page:

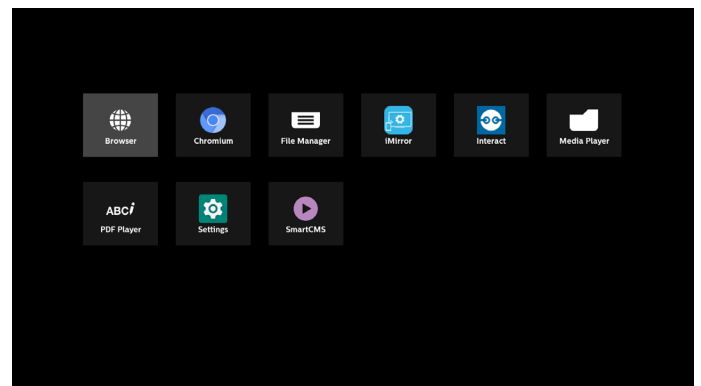

### 3) Network page

(Wi-Fi will not be visible if no Wi-Fi dongle is connected.)



#### 3.1) Ethernet page:

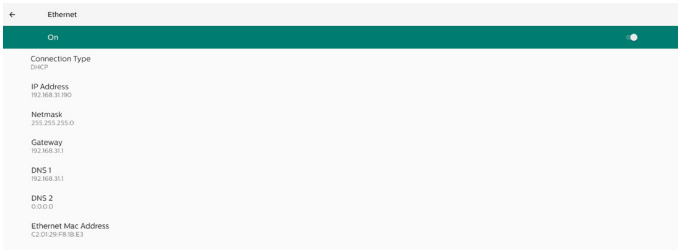

### 4) Storage page

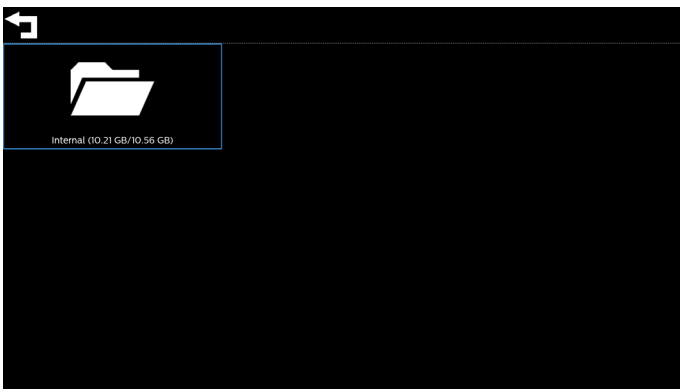

### 5) Help page

Display QR to link to Philips support website.

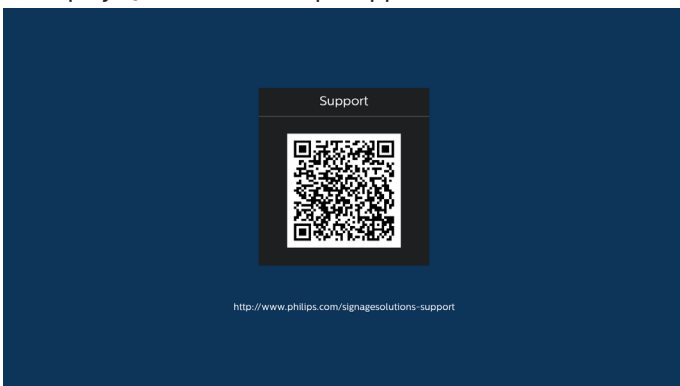

## 5.4. Media Player

### 5.4.1. OSD menu interaction with media player:

1. Boot on source:
  - Input:
    - If you select Media player as the source, the system will enter media player automatically after the boot process is completed.
  - Playlist:
    - Main page: go to the main page of media player.
    - Playlist 1 - Playlist 7: go to media player and playback File1 - File7 of playlist automatically
    - USB Autoplay: go to media player and play USB files automatically.
2. Schedule:
  - Schedule list:
    - Set up to 7 schedules.
  - Enable:
    - Enable/disable schedule.
  - Start time:
    - Set start time.
  - End time:
    - Set end time.
  - Playlist:
    - 1-7 : go to media player and playback File1 - File7 of playlist automatically.
    - USB AutoPlay: media player autoplay media file of USB storage.
  - Days of the week:
    - Set Sunday, Monday, Tuesday, Wednesday, Thursday, Friday, Saturday.
  - Every week:
    - Set a weekly schedule.
  - Save:
    - Save the schedule.

### 5.4.2. Media Player introduction:

1. The main page of Media Player, this page consists of three options: "Play", "Compose" and "Settings".  
Play: select a playlist to play.  
Compose: edit a playlist.  
Settings: set the properties of Media Player.

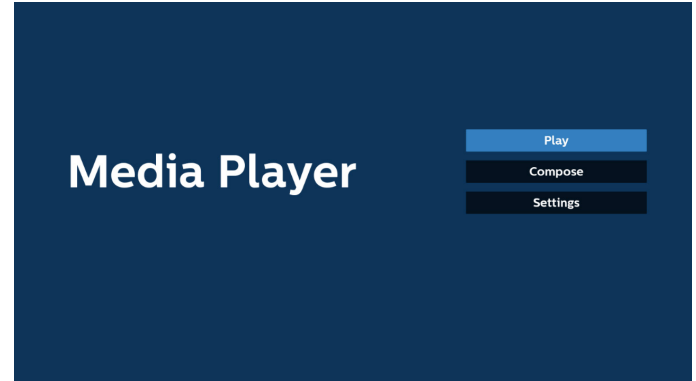

2. Select "Play" on the main page, first you should choose one playlist to play between FILE 1 and FILE 7. The pencil icon means that the playlist contains the content.



3. Select "Compose" on the main page, first you should select one playlist to edit between FILE 1 and FILE 7. The pencil icon means that the playlist contains the content.

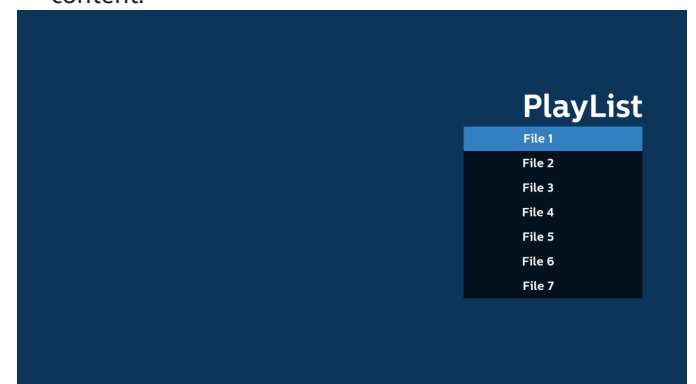

4. If an empty playlist is selected, the App will guide you through selecting the media source.  
All media files should be stored in /philips/ of root directory.  
For example,  
videos: {root dir of storage}/philips/video/  
photos: {root dir of storage}/philips/photo/  
music : {root dir of storage}/philips/music/

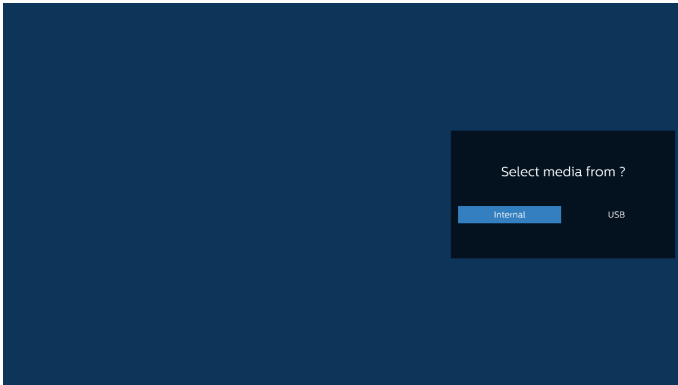

5. If you select "USB" storage, the App will guide you through selecting the USB device.

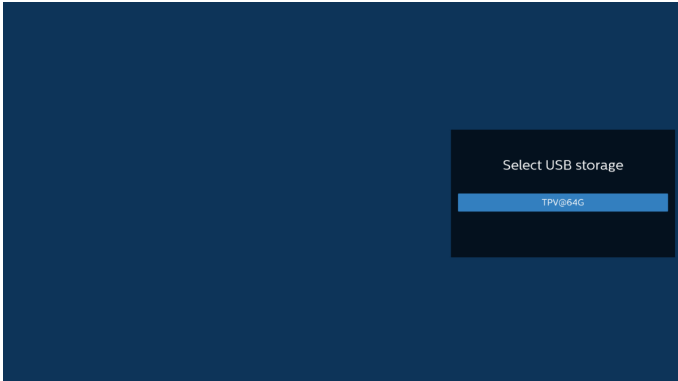

6. To edit or delete a non-empty playlist, select the desired playlist that has a pencil icon on right side of the selected file.

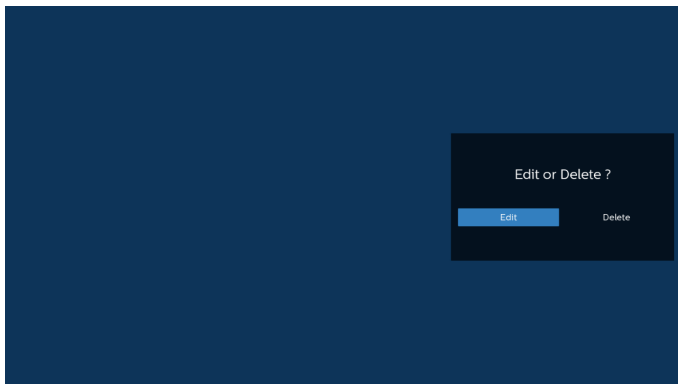

7. Once you start to edit a playlist, you will see below screen.  
 Source - files in storage.  
 Playlist – files in playlist.  
 Option – launch the side menu bar.  
 Play key – play the media file.  
 Info key – show the media information.  
 Touch file - select/deselect a file.

**Note:**

When long press on one of the directories in Source, full path will then be displayed.

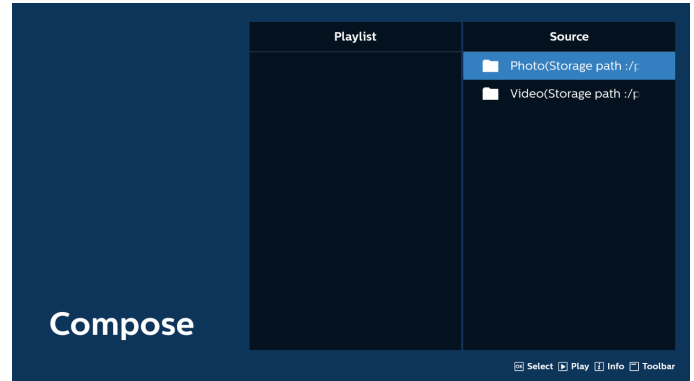

- 7-1 From the side menu bar, the following functions are available:

- select all: select all storage files.
- delete all: delete all playlist files.
- add/remove: update playlist from source.
- sort: sort playlist.
- save/abort: save or abort playlist.
- back: return to the previous menu.

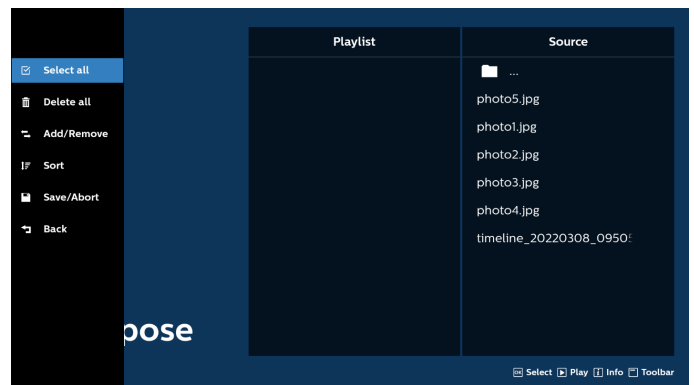

8. If "Sort" is selected, you can customize the file order severally.



9. After selecting the desired file, press “Info” key to obtain the detailed information.

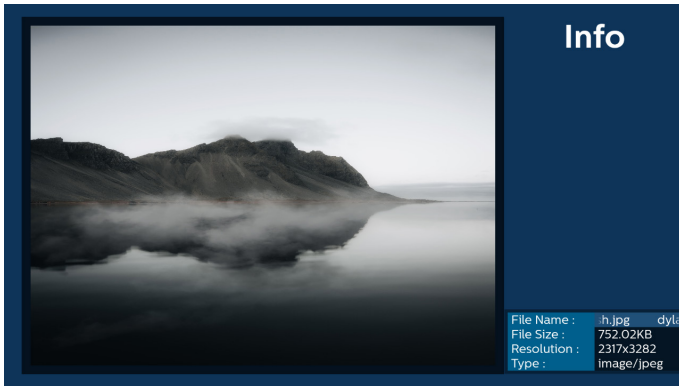

10. After selecting the desired file, press “Play” key to play the media file immediately.



11. If you create a playlist with all image files, you will be asked to add a background music to the slideshow before saving.

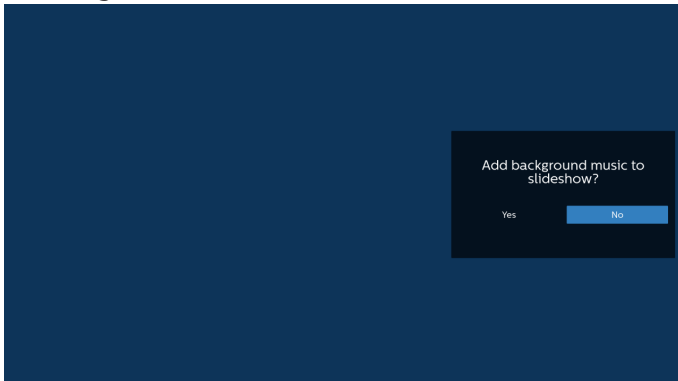

12. Select “Settings” on the main page, there are 5 options available: “Repeat Mode”, “Slideshow Effect”, “Effect Duration”, “Software Decode” and “USB Autoplay”.
- Repeat mode: set the repeat mode.
  - Slideshow Effect: photo slideshow effect.
  - Effect Duration: duration of photo effect.
  - Software Decode: no black screen between video play.
  - USB Autoplay: Plug in the USB device and it will play the files from USB root path automatically.

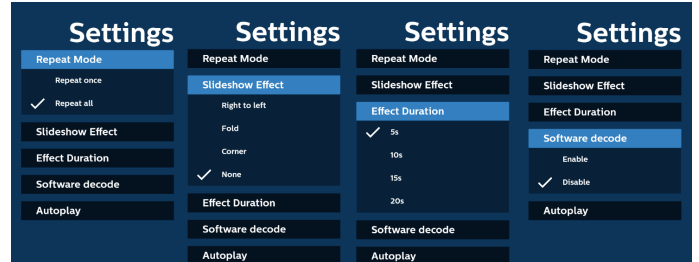

13. Media Player import text file

Step 1. Create media player text file.

- File name : mpplaylistX.txt, “X” means playlist number(1,2,3,4,5,6,7).

Ex. mpplaylist1.txt, mpplaylist2.txt

- Content :

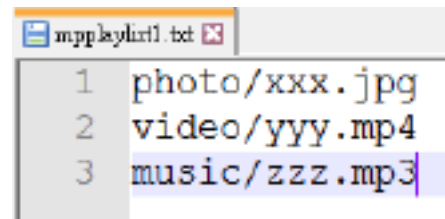

Note: If the playlist contains video and music files, the screen becomes black when playing music file.

Step 2. Copy “mpplaylistX.txt” to “philips” folder of internal storage. You may use FTP to do this.

- File path : /storage/emulated/legacy/philips (for DL, PL)
- Ex. /storage/emulated/legacy/philips/mpplaylist1.txt

Step 3. Prepare media files to “photo”, “video” and “music” folder under “philips” folder, internal storage only.

- Ex. /storage/emulated/legacy/philips/photo/xxx.jpg
- /storage/emulated/legacy/philips/video/yyy.mp4
- /storage/emulated/legacy/philips/photo/zzz.mp3

Step 4. Start media player app, it will automatically import media player text file.

Note: Once the playlist file (text) is imported, if user changes playlist via remote control, this change will not be reflected in the playlist text file.



## 5.5. Browser

Before using this feature, ensure that the system is connected successfully to the network.

(See 6.1.1.1. Wi-Fi & 6.1.1.2. Ethernet)

1. Main page of "Browser" App which allows you to make related settings.

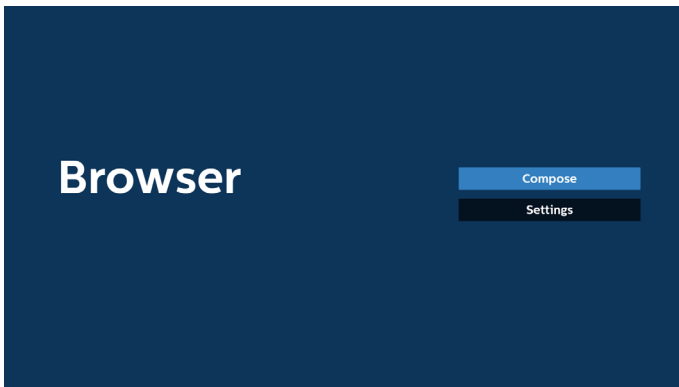

2. Press "Compose" then enter the next page. Users can choose between 1~7. A dialog box appears after the selection is made.

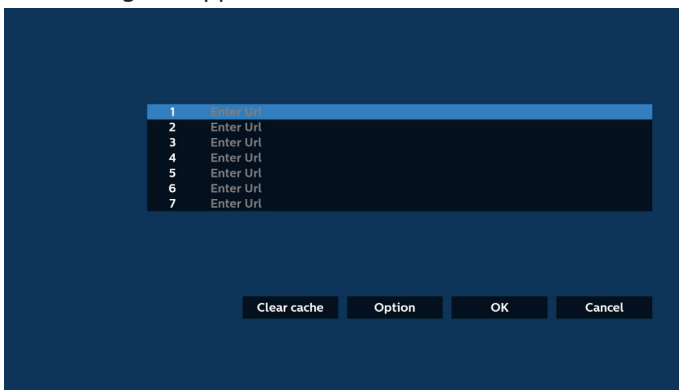

3. Use the on-screen keyboard to enter URL and press the OK button, the data will be saved in the List.

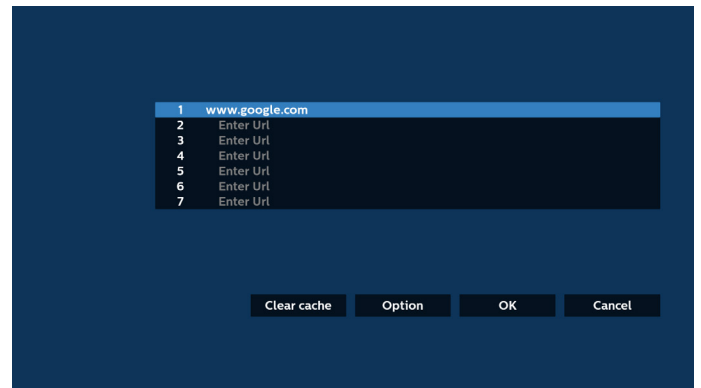
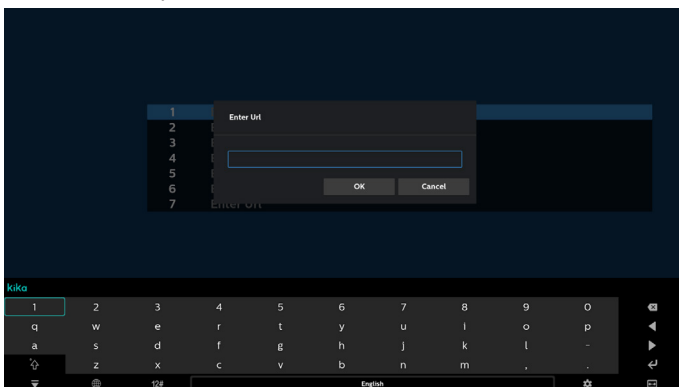

4. Press "Option" and a list will appear on the left side.
  - Import: Import the file of URL list
  - Export: Export the file of URL list
  - Delete all: Delete all URL records from the main screen
  - Back: Close the side menu bar

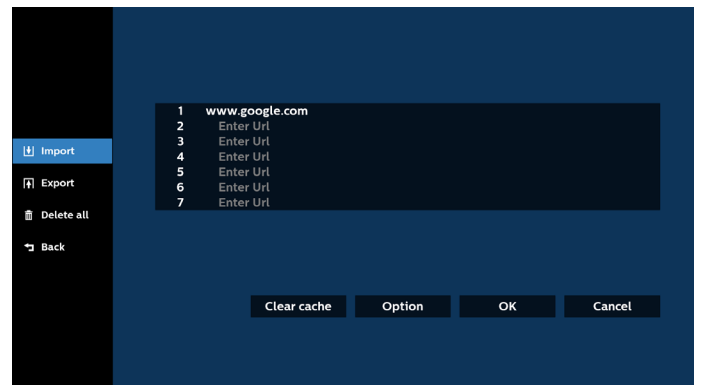

### 4.1 Import

- Select import.

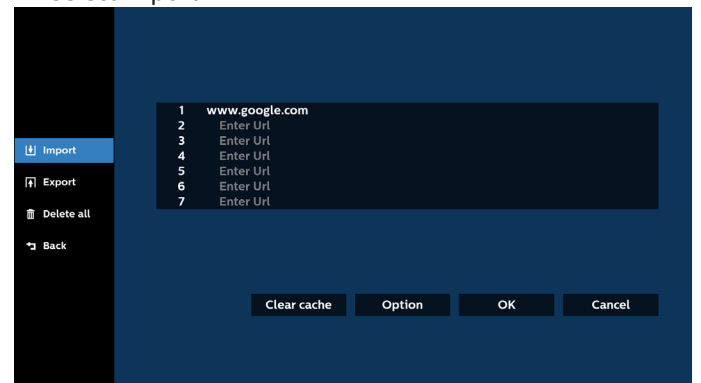

- Select the storage from which the file will be imported.

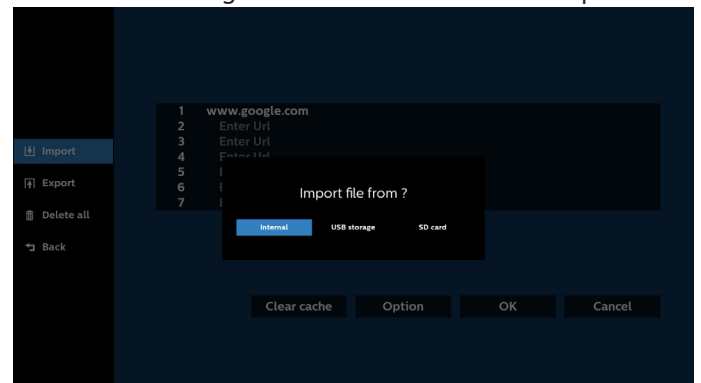

- Select a browser file.

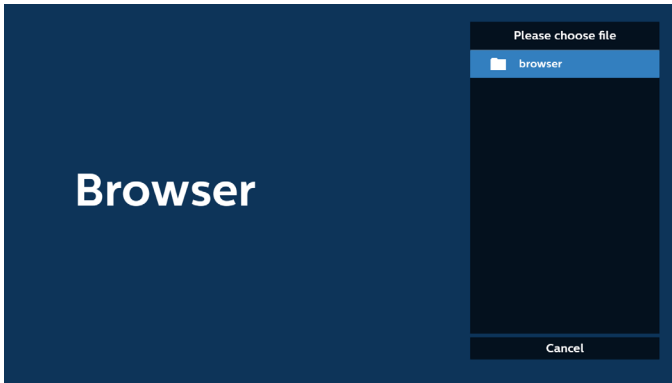

- Import the browser file and the URL will be listed on the screen.

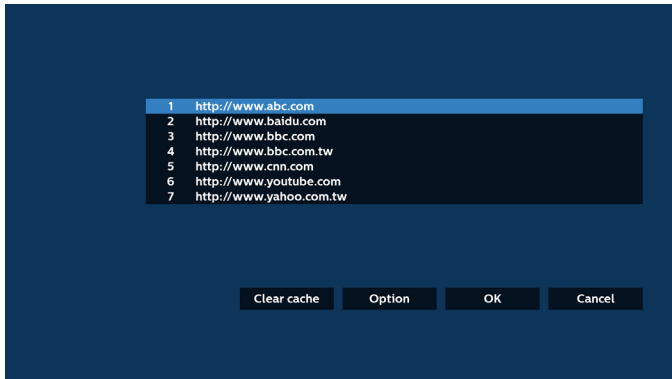

- The file format supported for import is ".txt".

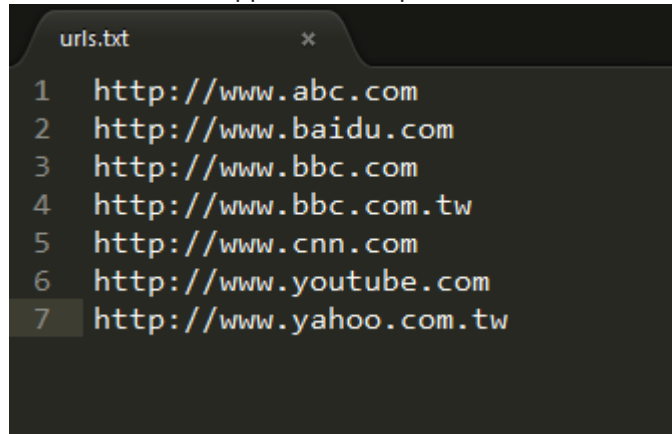

4.2 Export:

- Select export.

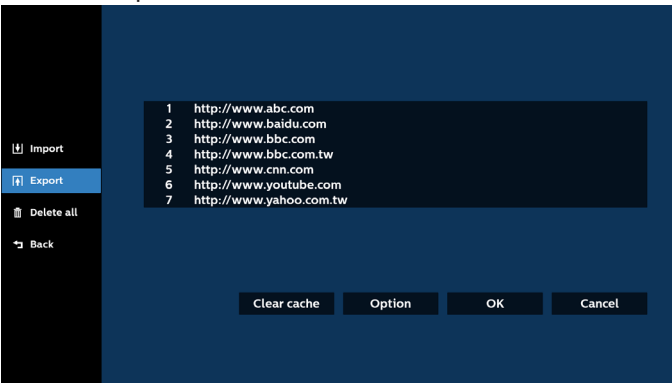

- Select the storage where the file will be exported to.

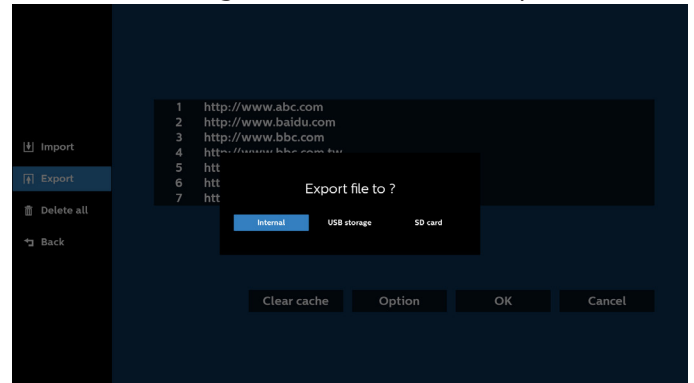

- A dialog box displays the path of the file to be saved as well as the file name. Press the "Save" button to save the URL.

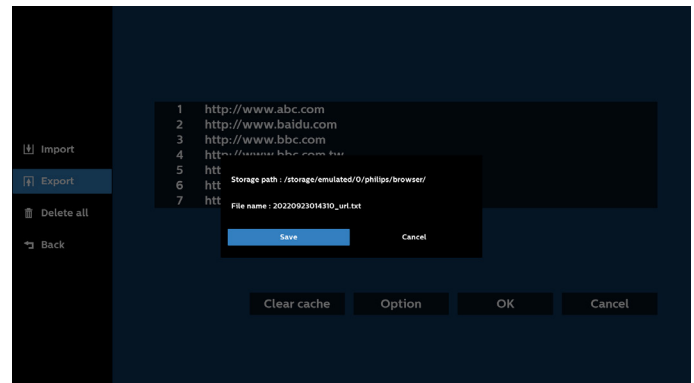

- 5. Press the "OK" button to save the URL record.

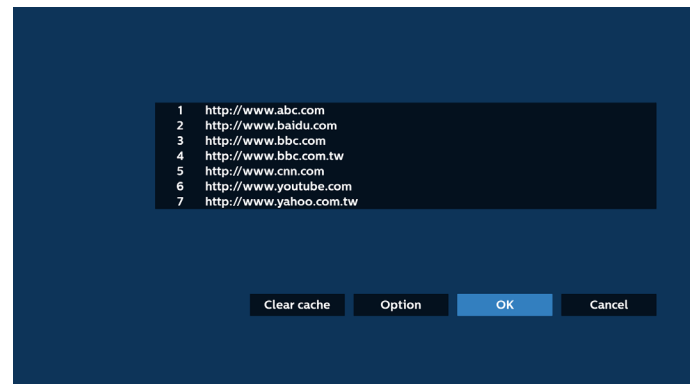

6. If you select a non-empty item from the URL list, a message will appear asking if you want to edit or play the URL. If you select "Edit" a dialog box allows you to edit the URL. If you select "Play", a web page of the selected URL appears.

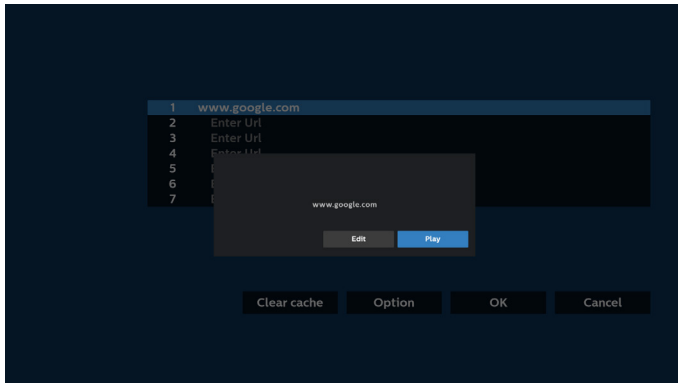
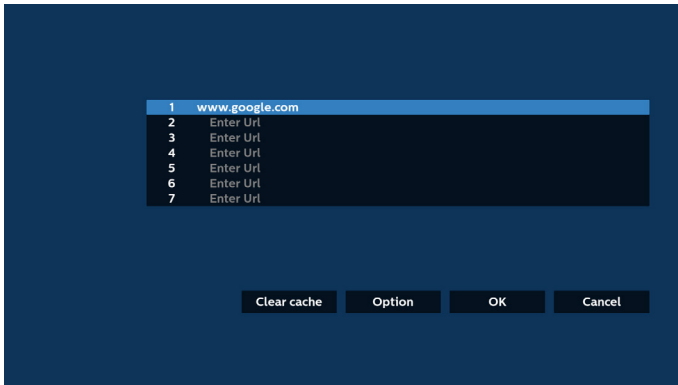

7. Press "Settings" then enter the next page.

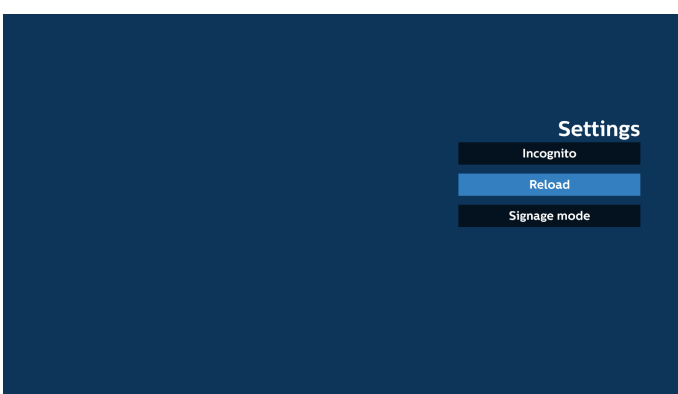
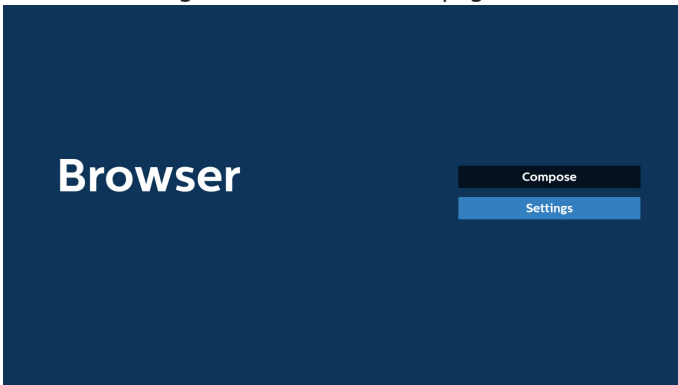

7.1 Incognito

- a. Enable : Display webpages using incognito mode.
- b. Disable: Display webpages using non-incognito mode.

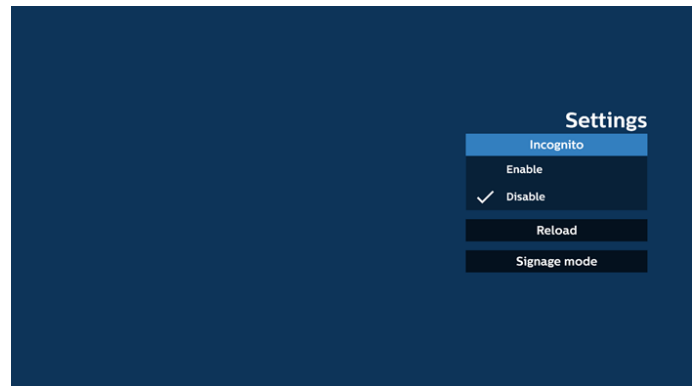

7.2 Reload

Allow users to set the webpage reload time.

a. If the enable checkbox is unchecked, the default reload time is 60 seconds.

Note:

In this case, the webpage only reloads when the network state changes.

If the network state is always connected, the webpage will not reload after 60 seconds.

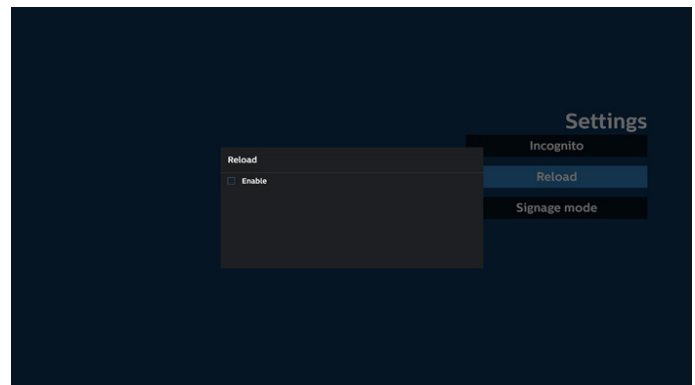

b. If the enable checkbox is checked, you can set the reload time.

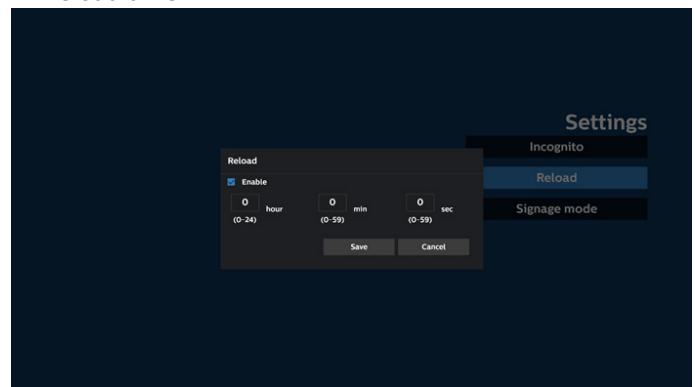

7.3 Signage mode

Enable going back to the Browser Compose page when the user returns from another app's activity. Disable keeping the Browser screen on the latest webpage. The option is enabled by default.

Open www.google.com and search for "PDF demo file". Click one PDF file in search result, the PDF file will be downloaded and opened. When user press "Back" button, the screen goes back to Browser Compose page if the option is enabled. The screen goes back to the search result if disabled.

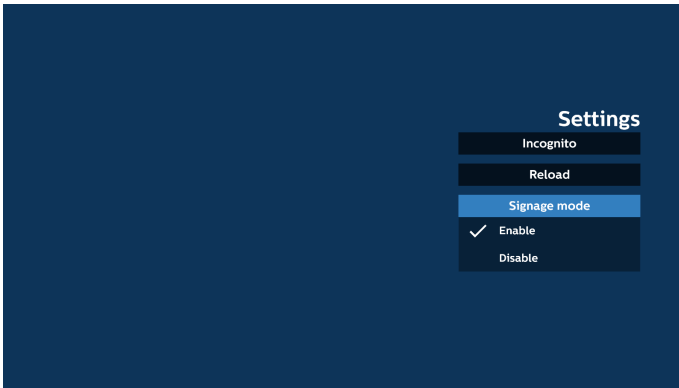

If the network is disconnected while the OSD scheduler is opening the browser app, the browser app will automatically open the URL 1 address home page from local storage.

Note:

- Browser app can only save Url 1 address home page data, data for Url 2 to Url 7 cannot be saved.
- Local storage: /sdcard/Download/OfflineBrowsing
- Pressing "Clear cache" button can clear Url 1 address home page data from local storage.

## 8. OSD menu interaction with Browser

### 8.1 Boot on source

- Set OSD menu > Configuration1 > Boot on source > set BROWSER Play List to 0.  
Then PD will show Browser after rebooting.
- Set OSD menu > Configuration1 > Boot on source > Input be BROWSER Play List be 1.  
Then PD will show the web page with 1st URL in Browser app.

### 8.2 Schedule

Set OSD menu > Advanced option > Schedule > On time1, Off time2, Browser as input, any day of the week and Play List.  
Then PD will show the web page with URL in Browser app at time1 and finish at time2.

## 9. How to edit the URL list via FTP

Step 1. Create a text file of media player.

- File name: bookmarklist.txt.
- Content:

```
bookmarklist.txt
1 https://www.google.com.tw/
2 http://abc.go.com/
3
4
5
6
7
```

Step 2. Copy bookmarklist.txt to "philips" folder of your internal storage. You may use FTP to do this.

- File path: /storage/emulated/legacy/philips (for DL, PL)

Ex. /storage/emulated/legacy/philips/bookmarklist.txt

Step 3. Start Browser App, it will import the text file of Browser automatically.

Note. Once the playlist file (text) is imported, any changes made through the remote control will not be recorded in the playlist text file.

## 10. Offline browsing

When an address is set with URL1 and OSD schedule is used to open URL1 web page, browser app will automatically save home web page data of Url1 to local storage.

## 5.6. PDF Player

### 5.6.1. OSD menu interaction with PDF player:

1. Boot on source:
  - Input:
    - If "PDF Player" is selected as the source, it will enter PDF Player page automatically after the boot process is completed.
  - Playlist:
    - Main page: go to the main page of PDF player.
    - Playlist 1 - Playlist 7: go to PDF player and playback File1 - File7 of playlist automatically
2. Schedule:
  - Schedule list:
    - Set up to 7 schedules.
  - Enable:
    - Enable/disable schedule.
  - Start time:
    - Set start time.
  - End time:
    - Set end time.
  - Playlist:
    - 1-7 : go to PDF player and playback File1 - File7 of playlist automatically.
  - Days of the week:
    - Set Sunday, Monday, Tuesday, Wednesday, Thursday, Friday, Saturday.
  - Every week:
    - Set a weekly schedule.

### 5.6.2. PDF Player introduction:

1. The main page of PDF Player, this page consists of three options: "Play", "Compose" and "Settings".

Play: select a playlist to play.

Compose: edit the playlist.

Settings: set PDF Player properties.

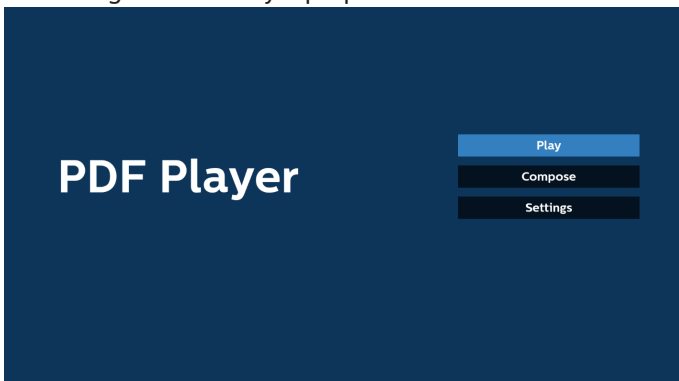

2. Select "Play" on the main page, first you should select one playlist to play between FILE 1 and FILE 7.

The pencil icon means that the playlist contains the content.

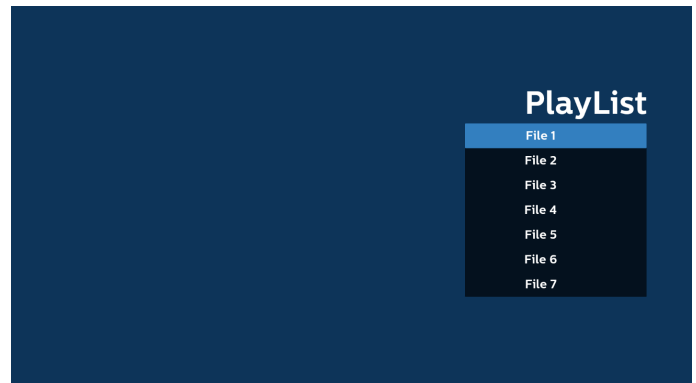

3. Select "Compose" on the main page, first you should select one playlist to edit between FILE 1 and FILE 7.

The pencil icon means that the playlist contains the content.

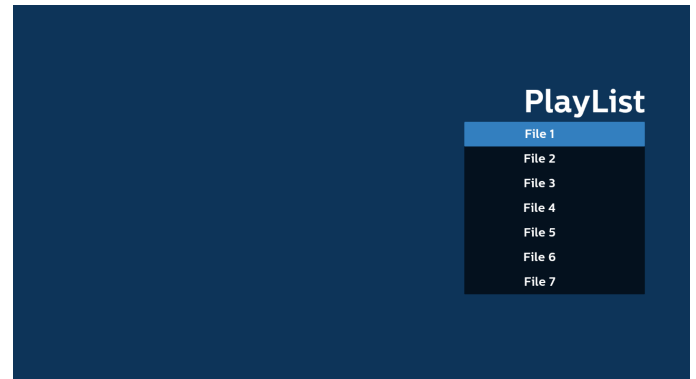

4. If an empty playlist is selected, the App will guide you through selecting the media source.

All media files should be stored in /philips/ of root directory. For example,

**pdfs : {root dir of storage}/philips/pdf/**

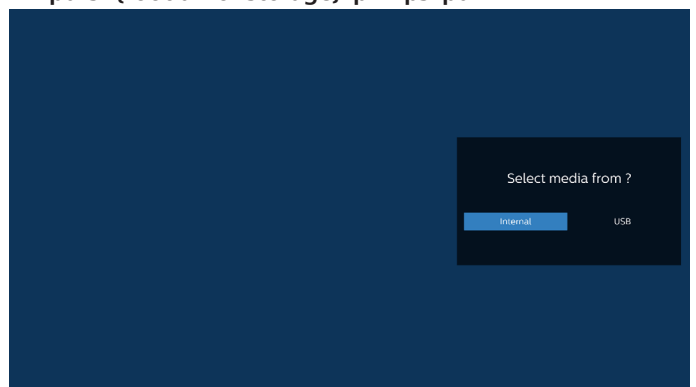

Note:

- If the USB stick cannot be found, the following message will be displayed. "Please plug in USB storage".

- Internal storage is always available, so it can navigate to the next page.

- To edit or delete a non-empty playlist, select the desired playlist that has a pencil icon on right side of the file.

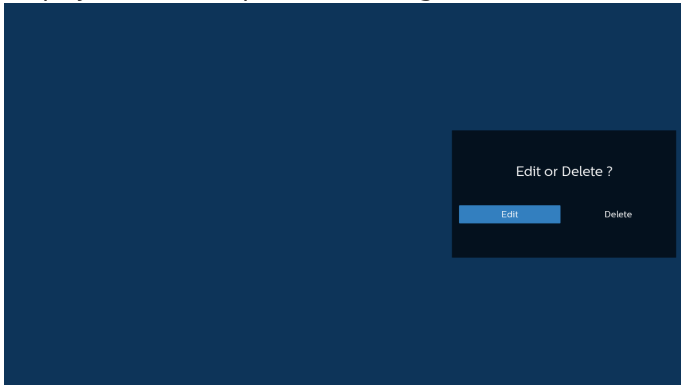

- Once you start to edit a playlist, a menu is displayed as below.

Source- files saved in the memory storage.

Playlist- files saved in the playlist.

The following functions can be operated through the corresponding keys on the remote control.

Option key – launch the side menu bar

Play key – play the media file.

Info key – show the media info.

Ok key – select/deselect a file.

- From the side menu bar, the following functions are available:

- Select all: select all files saved in the storage.
- Delete all: delete all playlist files.
- Add/Remove: add or remove a playlist from source.
- Sort: sort the playlist.
- Save/abort: save or abort the playlist.
- Back: return to the previous menu.

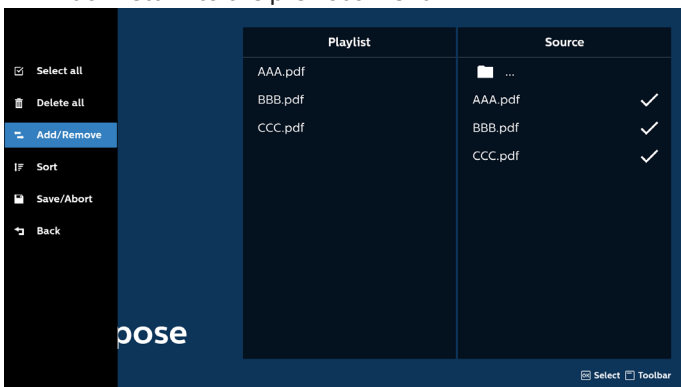

- If "Sort" is selected, you can customize the file order severally.

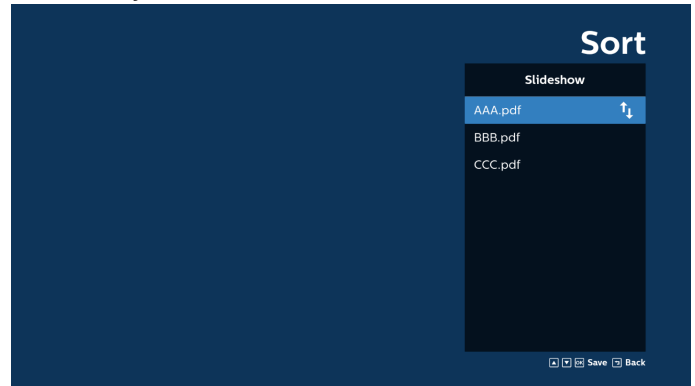

- Select "Settings" on the main page, there are three options available: "Repeat Mode", "Effect Duration" and "View Mode".

Repeat Mode: set the repeat mode.

Effect Duration: duration of photo effect.

View Mode : play with fit screen or play with original.

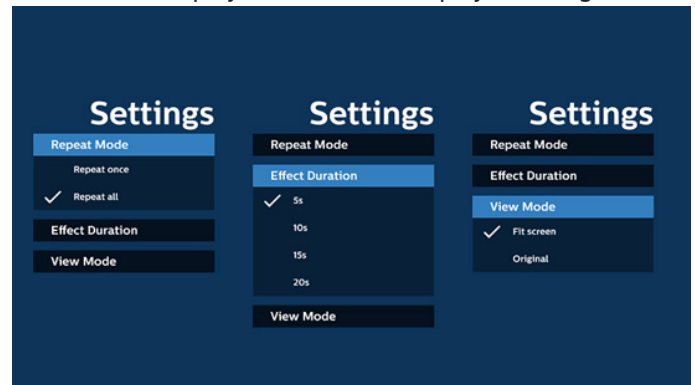

- How to edit the PDF list via FTP: Step 1. Create a text file of PDF player.

- File name : pdfplaylistX.txt, "X" means playlist number(1,2,3,4,5,6,7).  
Ex. pdfplaylist1.txt, pdfplaylist2.txt
- Content:

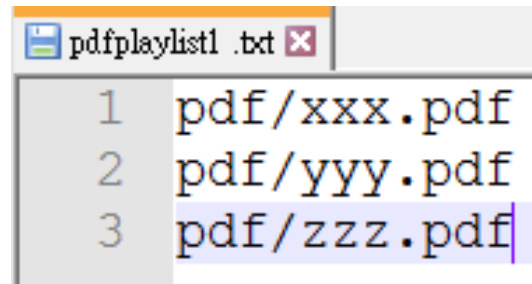

- Copy pdfplaylistX.txt to "philips" folder of the internal storage. You may use FTP to do this.

- File path : /storage/emulated/legacy/philips (for DL, PL)  
Ex. /storage/emulated/legacy/philips/pdfplaylist1.txt

- Add the PDF files to the "PDF" folder in the "philips" folder of your internal storage.

- Ex. /storage/emulated/legacy/philips/pdf/xxx.pdf  
/storage/emulated/legacy/philips/pdf/yyy.pdf  
/storage/emulated/legacy/philips/pdf/zzz.pdf

Step 4. Start the PDF player App, it will import the text file of PDF player automatically.

Note. Once the playlist file (text) is imported, any changes made through the remote control will not be recorded in the playlist text file.

#### Media Hotkey:

Play: play the file.

Pause: pause.

Fast forward: skip to the next page. If the page is close to the end of file, it will go to the next file.

Rewind: skip back to the previous page. If the page is close to the beginning of file, it will go to the last file.

Stop: return to the first page of file.

#### Arrow keys:

Up/Down/Left/Right: Adjust the page. (when the page is zoomed in/out)

Left: Previous page. (when the page is not zoomed in/out)

Right: Next page. (when the page is not zoomed in/out)

#### Combination key:

Number key + OK key: select a specific page and press OK key to change the page.

- Press a number key.

- Press OK key, the page number will be shown at the bottom of the page. If the page number exceeds the total page number, the current page number will remain at the bottom of the page.

#### Note:

If you plug in two or more USB disks to edit the playlist, playback from the playlist cannot be guaranteed after powering on/off, due to the USB storage path may be changed. It is strongly recommended to use only one USB disk when editing the playlist.

## 5.7. Custom App

Set up the application for Customer Source.

Note:

- (1) It only displays the App installed by user.
- (2) System's pre-installed App is not displayed.

### 5.7.1. OSD Menu operation:

RCU: Source > Custom

If a customer APK is set, the PD will open the customer App when switching the source to Customer mode.

If the customer APK is not set, the PD will show a black screen when switching the source to Customer mode.

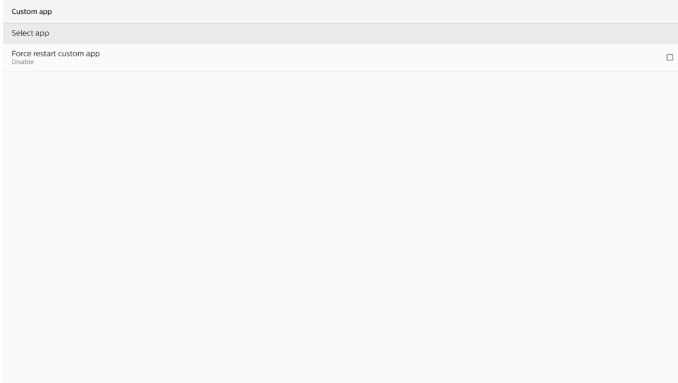

### 5.7.2. Function Introduction

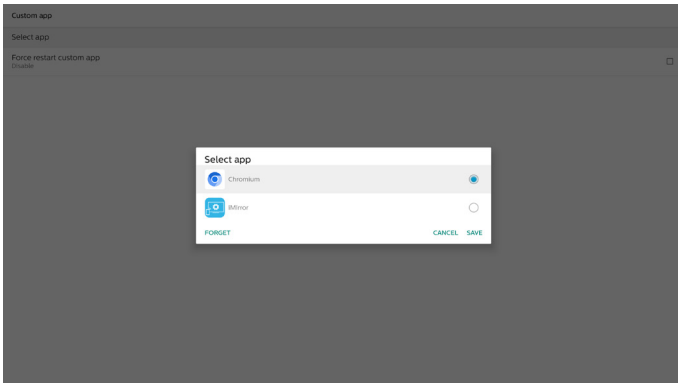

#### Save

Pressing "Save" will perform the function of storing.

#### Forget

After pressing "Forget", those previously stored information can be removed.

#### Cancel

Cancel and close the dialog box.

If there is no customer installed APK, the list will be blank.

If the options are not available, "Save" and "Forget" keys will be shown in gray.

#### Force restart custom app

If the app is closed due to an exception, the app will be automatically reopened.



## 6. Setting

### 6.1. Settings

Enter PD settings by clicking “Settings” icon in Admin mode.

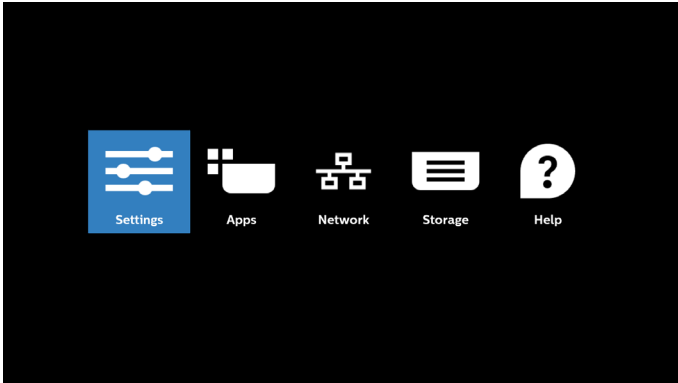

Setting menu consists of the following items:

- (1) Network & Internet
- (2) Connected devices
- (3) Signage Display
- (4) Apps
- (5) Security
- (6) Accessibility
- (7) System
- (8) About

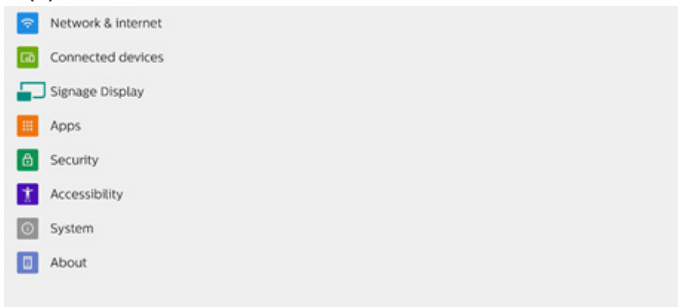

#### 6.1.1. Network & Internet

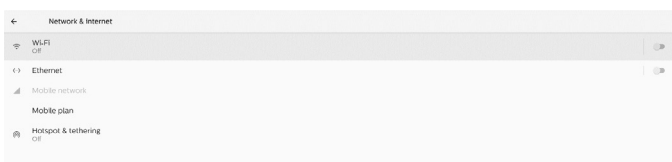

##### 6.1.1.1. Wi-Fi

Settings -> Network & Internet -> Wi-Fi

**Important Note:** This option is available only when the supported Wi-Fi dongle is plugged. Reboot the device whenever you plug or remove the USB Wi-Fi dongle.

##### Enable Wi-Fi

Enable/disable Wi-Fi connection through main switch in Setting -> Network & Internet -> Wi-Fi -> Off/On toggle button.

##### Wi-Fi Off

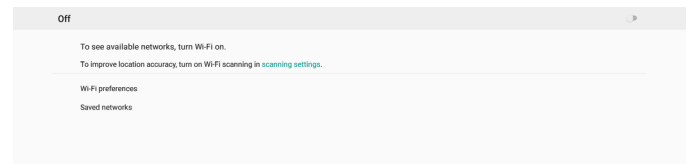

##### Wi-Fi On

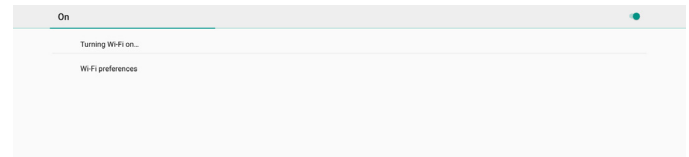

On the available network list, select an AP (access point) on an existing wireless network.

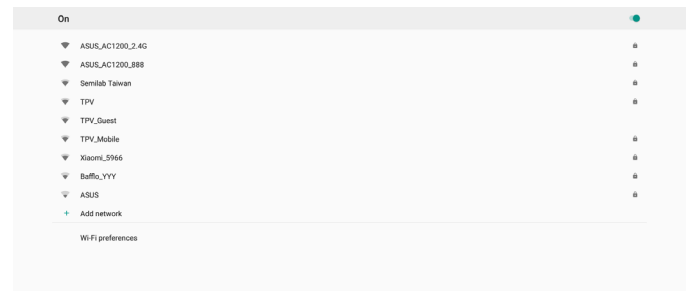

Enter the required settings.

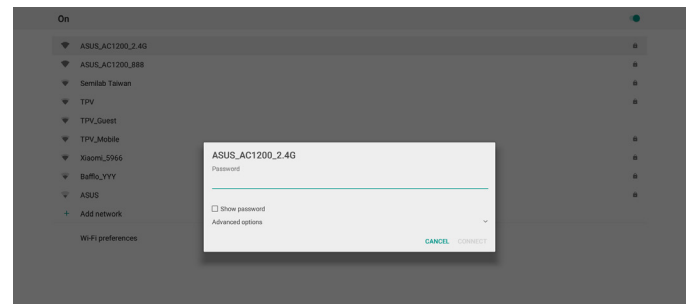

There is an “Add network” item at the end of list. If network is not listed, use “Add Network” to join a hidden network.

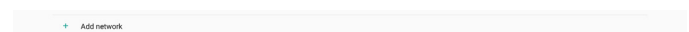

You must input network SSID, security type and other advanced options for this network.

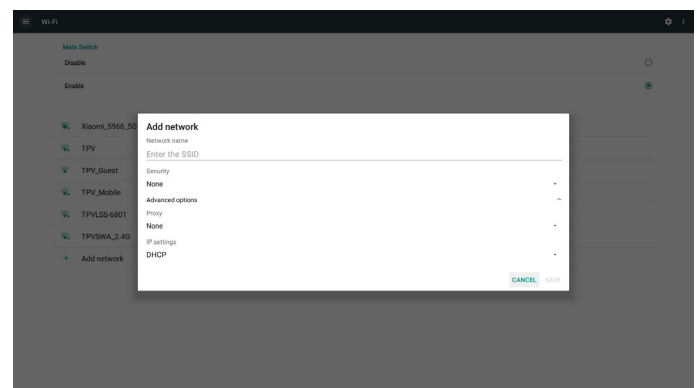

**Note:**

When Wi-Fi is enabled, Ethernet will be disabled automatically.

## Wi-Fi Preference

Settings -> Network & Internet -> Wi-Fi -> Wi-Fi Preference

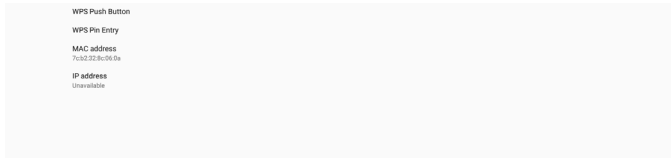

### Using WPS

WPS network can be enabled using 2 options:

PBC (Push Button Configuration), in which the user simply has to push a button to connect.

PIN (Personal Identification Number), in which a PIN will be entered in client WPS device to connect.

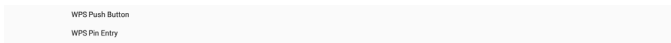

When using PBC method, select "WPS Push Button" to connect.

When using PIN method, select "WPS Pin Entry" and enter the PIN to connect.

### Wi-Fi Network Information

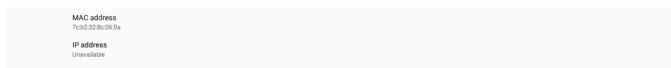

MAC address: shows Wi-Fi MAC address.

IP address: shows the IP address when the device joins a network.

## 6.1.1.2. Ethernet

Settings -> Network & Internet -> Ethernet

### Enable Ethernet

Enable/disable Ethernet connection by Setting -> Network & Internet -> Ethernet toggle button.



By default, the system uses DHCP to join the network.

Connection Information (When the options are grayed out, they are not editable).

- A. IP Address
- B. Gateway
- C. Netmask
- D. DNS 1
- E. DNS 2
- F. Ethernet Mac Address

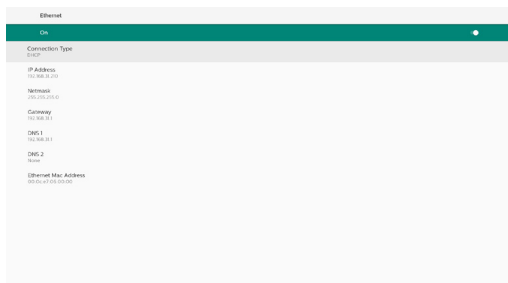

Note:

Wi-Fi connection will be disabled automatically when Ethernet connection is enabled.

### Ethernet Static IP

When the Connection Type is changed to "Static IP", the user can manually set the Ethernet IP Address, Gateway, Netmask and DNS 1/2 address.

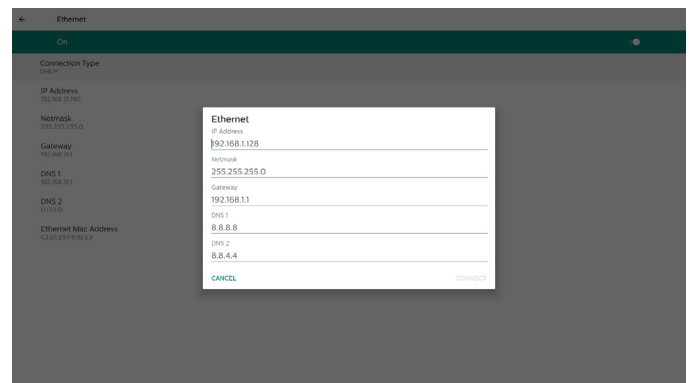
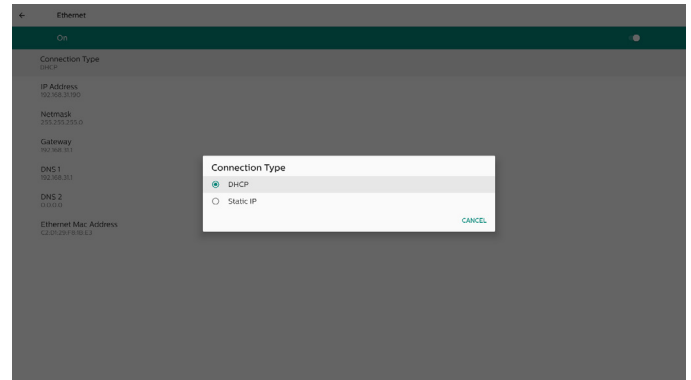

Note:

1. Please input IPv4 address in all fields; in dot-decimal notation, consisting of four decimal numbers, each ranges from 0 to 255, separated by dot.

### 6.1.1.3. Mobile networks

This option is shown when a device is plugged in and supports a 4G module with a SIM card. The system does not support hot-plugging of the 4G module, so please shut down the system (AC off) before installing the 4G module to the device, and then power it on again.

Switch to enable the main switch in Settings -> Network & internet -> Mobile network to enable mobile network. The SIM card must be plugged into SIM card slot before using it.

### 6.1.1.4. Wi-Fi Hotspot

This system provides “Wi-Fi Hotspot”.

“Wi-Fi hotspot”:

Share network through Wi-Fi. When it is enabled, the Wi-Fi turns off connection and becomes a hotspot AP (access point). Other Wi-Fi client devices can join and share network.

User can set up detailed Wi-Fi hotspot information when enabling “Wi-Fi hotspot”.

The network name is the SSID name and must follow IEEE802.11 specification, it is suggested to use 0-32 octets with UTF8 encoding. The system provides NONE and WPA2 PSK security protocol to provide hotspot network. It is suggested to use WPA2 PSK as it is more secure than NONE.

The password for other client to connect is randomly generated, user can set a new password for the hotspot. Select the AP Band, which can be either 2.4 GHz band or 5.0 GHz band.



### Disable Tethering

By default, devices can use mobile data to access network via a hotspot. If enabling the option, the system will block devices from network access by hotspot.

### 6.1.2. Connected devices

Show the devices connected via Bluetooth.

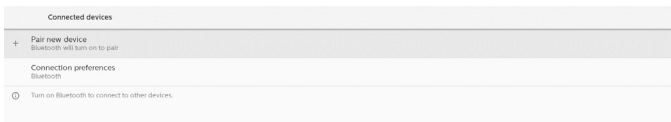

### 6.1.3. Signage Display

Settings -> Signage Display, to setup most features of signage display. See below for more detailed information about Signage Display settings.



#### 6.1.3.1. General Settings

Settings -> Signage Display -> General Settings

Set up Signage Display name, User logo and Screenshot.

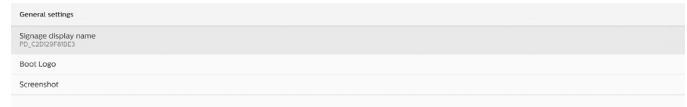

#### Signage Display Name

Settings -> Signage Display -> General Settings -> Signage Display Name

Set up the Signage Display name, the default name is the Ethernet MAC address with a prefix “PD\_”. For example, “PD\_000b12223398”. The maximum length of the name is 36 characters in UTF8 format. Click to rename it.



#### Boot Logo

Settings -> Signage Display -> General Settings -> Boot Logo

User can set up device boot up logo (boot animation) when OSD Menu -> Configuration 2 -> Logo is set to “User” mode.

If the Logo is not set to “User” mode, the user will not be able to select a custom boot animation.

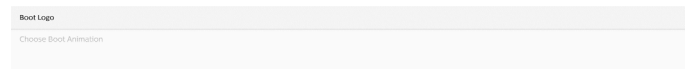

When set to “User” mode, the “Choose Boot Animation” becomes available.

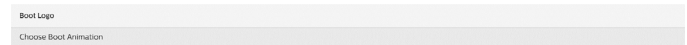

When Logo is set to User mode, the system will disable the default Philips logo and replace it with the user selected boot animation file. If user does not set a boot animation file for User mode, the default Philips boot animation will be displayed during boot time.

Click “Choose Boot Animation” to pop up a dialog for the user to select a boot animation file. The system will automatically scan the files under the USB storage.

The boot animation file name must be set to “bootanimation.zip”, any other name is invalid.

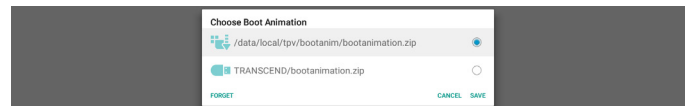

All available boot animation files can be found in the following folder:

- File under /data/local/bootanimation/:  
The boot animation file that was copied from USB.
- File under {USB\_STORAGE\_VOLUME\_NAME}/:  
The boot animation file saved on the USB storage.

Dialog options:

- FORGET  
Clear “bootanimation.zip under /data/local/bootanimation/.  
Custom boot animation will not be used during system boot up.

2. CANCEL

Cancel and close the dialog box.

3. SAVE

Copy the selected file to /data/local/bootanimation/. After doing this, user can remove their external storage (USB). System uses the boot animation file under /data/local/bootanimation.

If the system does not found any bootanimation.zip file under external storage (USB) and /data, the file list will be empty. The "SAVE" and "FORGET" buttons will be grayed out, user should check the content saved on the USB memory. Click "CANCEL" button to close the dialog box, and plug in the USB memory again.

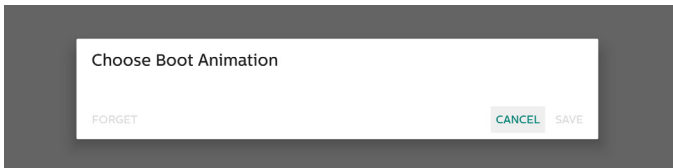

If /data/local/bootanimation/ folder is empty, it means that "bootanimation.zip" has not been saved by the user before. Default Philips logo appears during system boot up.

When "bootanimation.zip" is found in the external storage, a dialog box displaying the list of files will appear.



If the file "bootanimation.zip" can be found in the folder "/data/local/bootanimation/", the pop-up dialog box will show that file as the first option. It simply means that user has previously copied (saved) the file "bootanimation.zip" and that the system will boot up with boot animation from /data/local/bootanimation/bootanimation.zip.

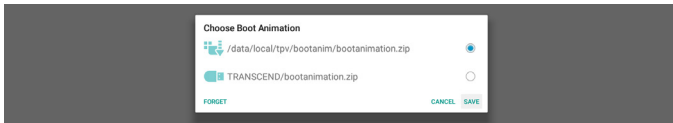

Boot animation file can be replaced by using the "SAVE" button.

Screenshot

Settings -> Signage Display -> General Settings -> Screenshot

To capture the screenshots from the imported content, click "Enable" to enable the auto screenshot function. If the screenshot options are grayed out, it means that the screenshot function has not been enabled yet.

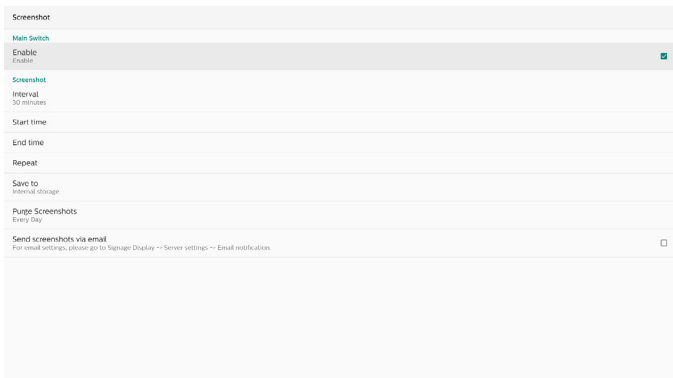

After enabling this feature, you can set the interval time between each screenshot, as well as the destination folder where the captured screen will be saved. The option "Save to" notifies you that the screenshot images will be saved to the internal storage and they cannot be changed manually.

NOTE:

- The screenshot images will be deleted automatically under the following conditions:
  - When the start time of the screenshot feature is set to 0 seconds.
  - Starting the screenshot at 40 seconds of minute.
  - If you decide to purge the screenshot photos every week, the data of deleting the photos will be changed to the day that you apply the setting of screenshot feature. For example, if you set the purging day to Monday of every week, then changed other settings in screenshot feature on Friday, the purging day will be changed to Friday (the day of the system's current time).
- Sleep (system suspend) and screenshot feature: The screenshot feature is suspended when the system enters sleep mode. The function of mailing out the screenshot is consequently suspended. The screenshot-related features will be restarted when the system enters active mode.

(1).Interval

Set the interval time between each screenshot. The available options are 30 and 60 minutes.



(2).Start Time

Set the start time of a day to begin the screenshot function.

Make sure that you click the "Save" button before leaving the dialog box, or your settings will not be saved.

The start time must be lesser than the end time. A toast message will appear notifying you if it is an invalid value.

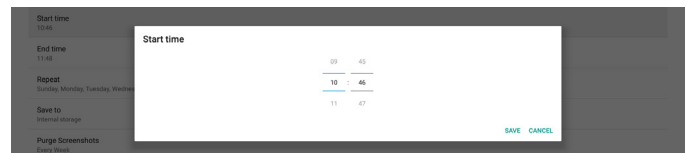

**(3).End Time**

Set the end time of a day to end the screenshot function. Make sure that you click the “Save” button before leaving the dialog box, or your settings will not be saved. The start time must be lesser than the end time. A toast message will appear notifying you if it is an invalid value.



**(4).Repeat**

Set the repeat mode for auto screenshot.



**(5).Save to**

The screen images will be saved in the folder “philips/screenshot” of the internal storage.

**(6).Purge Screenshots**

Set the interval time for deleting the screenshot images. The available options are “Every day” and “Every week”.



**(7).Send screenshots via email**

You can send each screenshot image as an e-mail attachment. The user must first set up the mail information in “Settings -> Signage Display -> Server Settings -> Email notification” (Refer to [Email Notification](#) section).



**6.1.3.2. Server Settings**

Settings -> Signage Display -> Server Settings



**Email Notification**

Settings -> Signage Display -> Server Settings -> Email Notification

Click the checkbox to enable/disable E-mail notification feature. Set SMTP and manager E-mail after enabling the E-mail notification feature.



**SMTP**

Set up the sender E-mail address and SMTP server information. There are two types of SMTP server for user to set up: “Gmail” and “Other”. By using the “Other” option, user can manually set up an SMTP server, security type and server port.

**Note:**

1. The password should be in UTF8 format with 6 to 20 characters.
2. User cannot set port 5000 (SICP default port) and 2121 (FTP server default port).  
SICP network port setting in “Settings -> Signage Display -> Network Application -> SICP network port”.  
FTP network port settings in “Settings -> Signage Display -> Server settings -> FTP -> Port”.

Gmail: (SMTP server, Security type and Port are grayed out)

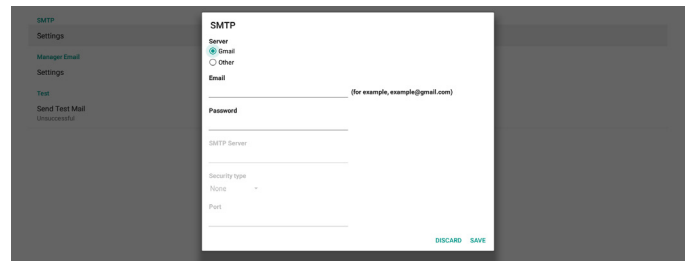

**Other:**

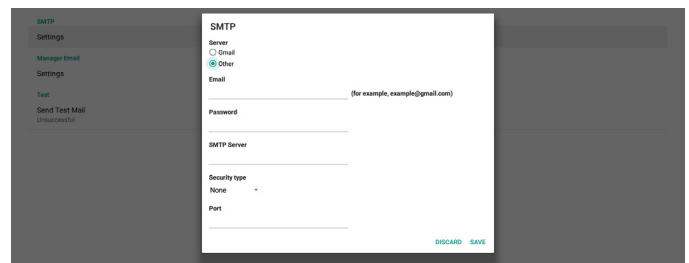

**Gmail Security Settings**

Open a web browser and login into your Google account. Click on the “Security” menu which can be found either on the left or at the top of the webpage.

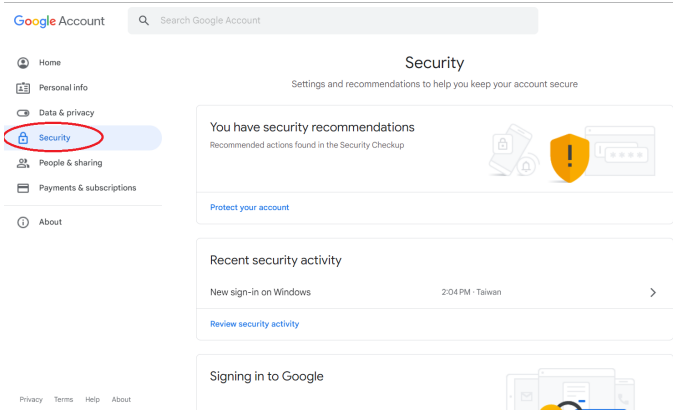

**Step 1 - Select "2-Step Verification"**  
If 2-Step Verification is off, click to enable it.

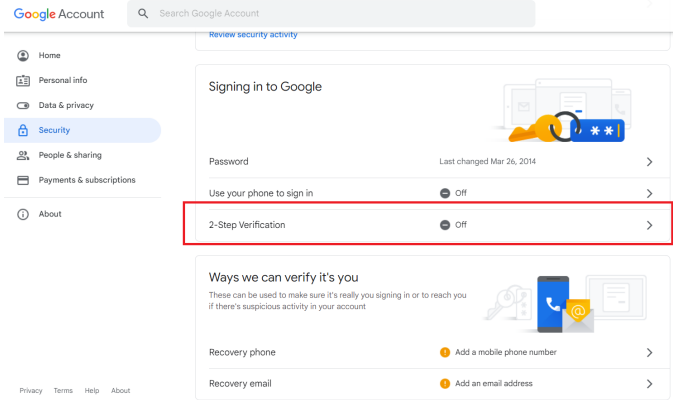

**Step 2 - Configure 2-Step verification**  
Click the "GET STARTED" button to start configuring the 2-step verification options.

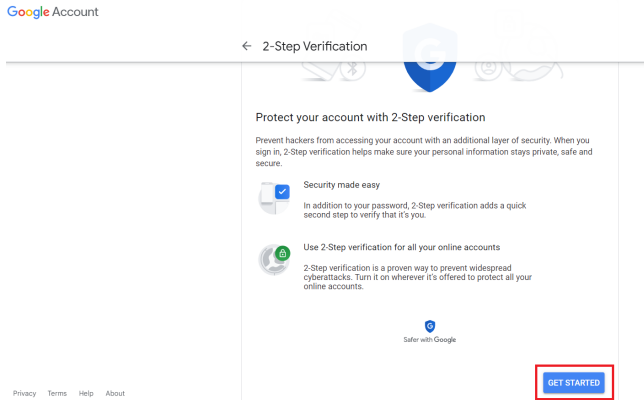

You may be prompted to log in to your Google Account again to confirm your identity.

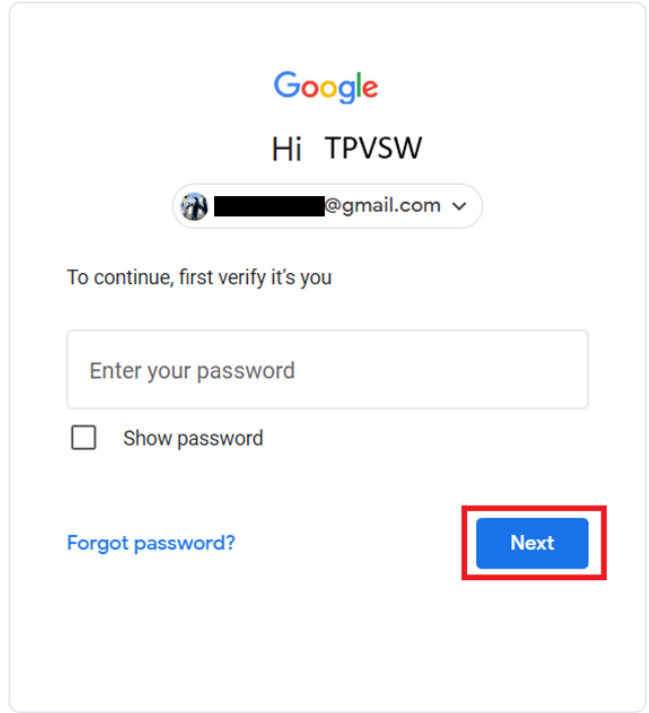

English (United States) Help Privacy Terms

**Step 3 - Use your phone to complete configuration**  
Use on-screen instructions and available options to complete 2-Step verification using your phone.

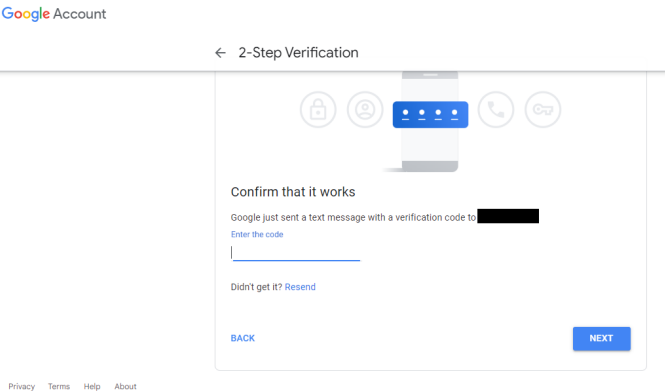
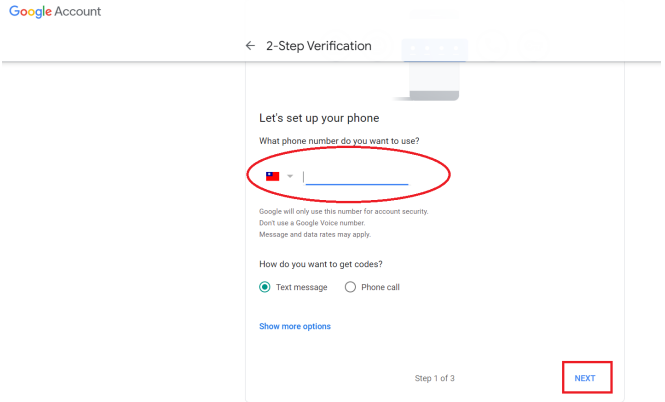

Record the auto-generated app password or simply select it and copy to the clipboard for later use.

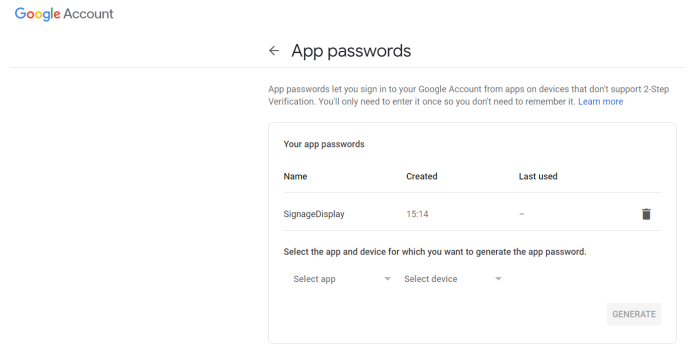
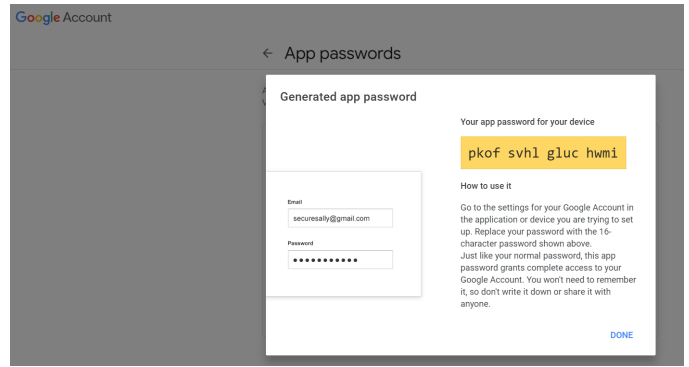

### Manager Email

Specify the destination address to receive the e-mail.



### Test

To check if your e-mail settings are correct, select 'Send Test Mail' to send a test e-mail.

### FTP

Settings -> Signage Display -> Server Settings -> FTP



Click the checkbox to enable/disable FTP server feature. After enabling this feature, user can setup an account, password and port number.

- (1). Account: The user name to log into the FTP server must be between 4 and 20 characters long, and only alphanumeric characters (a-z, A-Z, 0-9) can be used.
- (2). Password: The password to log in to the FTP server should be between 6 and 20 characters long, and can only contain the characters [a-z], [A-Z], and [0-9]. After setting the password, it will be displayed as asterisks.
- (3). Storage path: The FTP server has access to the internal storage only. The storage path is unchangeable.

< 2-Step Verification

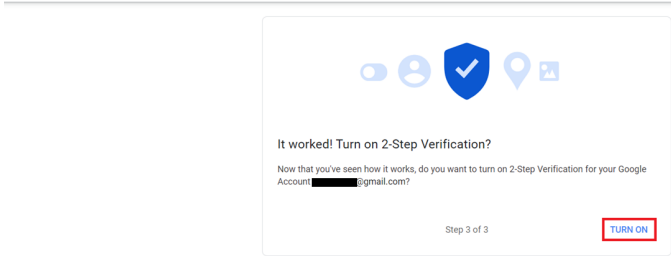

### Step 4 - Create the App Password

Click on the "App Password" option to create a new application password:

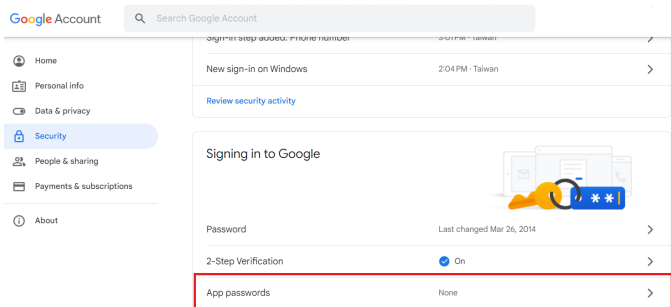

### Step 5 - Add New App Name

First, select a device (for example, Windows Computer) and then click on "Select App" menu and choose "Other (custom name)":

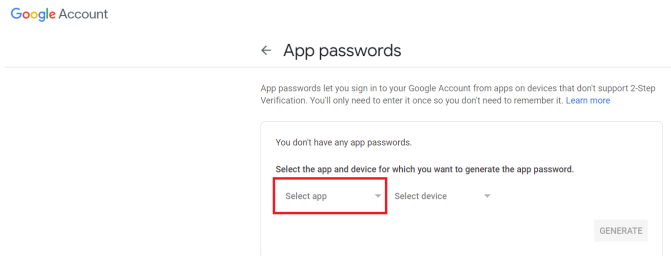

Enter a custom application name (it does not matter what name is used in this field). Click the "Generate" button: (Ex. Enter "SignageDisplay" as an app name)

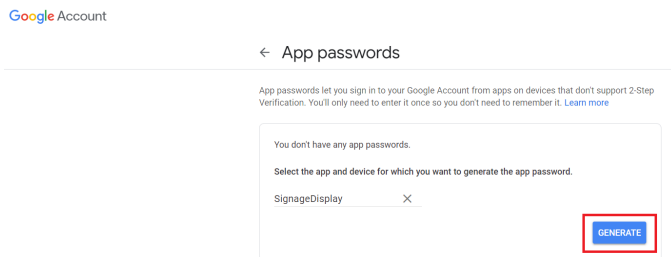

- (4).Port: The port number for the FTP server is available in the range from 1025 to 65535, the default setting is 2121. The following port number cannot be used: 8000 / 9988 / 15220 / 28123 / 28124 and SICP network port (default 5000).

Finally, manually reboot the system to apply the FTP settings.

## Remote Control

Settings -> Signage Display -> Server Settings -> Remote Control



Click the checkbox "Enable" to enable or disable the remote control client service. The default setting is "Enabled". To use the remote control feature, the device must be bound with the remote control server.

In the entry field of "Server", input the URL address with the prefix of "https://". If the device is not bound with the remote control server, please enter the PIN code provided by the server.

### Bind status:

- (1).If the device does not have an appropriate network connection, a message "Network is disconnected" will appear.
- (2).If the device is equipped with a network function, but is not connected to the remote control server, a message "Server is disconnected" will appear.
- (3).If a server is connected, but not bound, a message "Server is unbound" will appear.
- (4).If the device is bound with the server successfully, a message "Server is binded" will appear.
- (5).If the PIN code is not correct, a message "Error PIN code" will appear.

## SNMP

Enable/Disable the SNMP service.

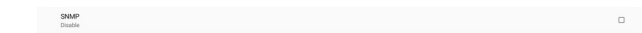

Please refer to the SNMP user manual.

## ADB over Network

You can access ADB over a network connection with port 5555.

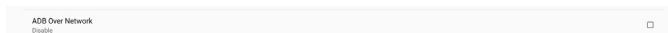



### 6.1.3.3. Source Settings

Settings -> Signage Display -> Source Settings

Users can configure the detailed options of the source APK.



#### Media Player

Settings -> Signage Display -> Source Settings -> Media Player

Open Media Player APK's edit play list activity and edit effect settings activity.



#### Browser

Settings -> Signage Display -> Source Settings -> Browser

Open Browser APK's bookmark editor activity.



#### PDF Player

Settings -> Signage Display -> Source Settings -> PDF Player

Open PDF Player APK's edit play list activity and edit effect settings activity.

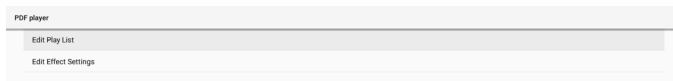

#### Custom app

Settings -> Signage Display -> Source settings -> Custom app

User can set up customer source APK. The selected APK will be launched when switching into customer input source. If customer source APK is not set, the system shows a black screen when switching to customer input source.

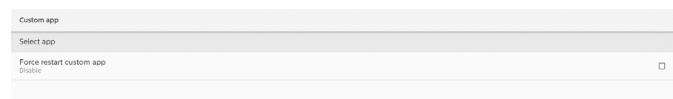

If a custom source APK is set, the APK name will be displayed. Otherwise, it means that the custom App has not been set.

#### Select APP

Select a specific APP for custom APP source.



Note:

The APKs pre-installed by the system will not be shown on the list. Only the APKs that were installed manually will be listed.

#### (1).FORGET button

Clear the custom source application. It will be grayed out if the customer source application has not been set.

#### (2).CANCEL button

Quit without saving changes.

#### (3).SAVE button

Click the "Save" button to select the APS as the custom source application. It will be grayed out if no available application can be selected.

#### Force Restart Custom APP

When this feature is enabled, the system can monitor the status of custom APP. If the custom APP doesn't exist and that boot on source is set to "Custom app", the system will then try to launch custom APP again.

Default setting is Disable.

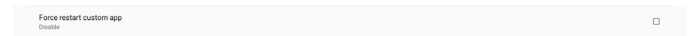

### 6.1.3.4. Network Application

Settings -> Signage Display -> Network Application

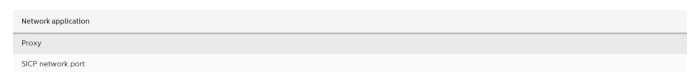

#### Proxy

Settings -> Signage Display -> Network Application -> Proxy

Enable the proxy server by clicking the checkbox of "Enable". User can set up the host IP and port number of the proxy server. The default setting is "Disable".



System supports the following proxy types: HTTP, HTTPS, SOCKS4, and SOCKS5. Choose one for your proxy server.



If an authorization is requested by proxy server, click the checkbox of "Authorization" and enter the username and password.



#### SICP Network Port

Settings -> Signage Display -> Network Application -> SICP Network Port

Set up the default port of SICP and enable/disable the network SICP. The default SICP is enabled with the port 5000.

**Note:**

Port number ranges from 1025 ~ 65535.

The following ports are already occupied and cannot be assigned: 8000, 9988, 15220, 28123, 28124. The default FTP port is 2121.



**6.1.3.5. System Tools**

Settings -> Signage Display -> System Tools

There are six major features in signage display system tools:

- (1).Clear Storage
- (2).Reset
- (3).Import & Export
- (4).Clone
- (5).Security
- (6).Admin Password

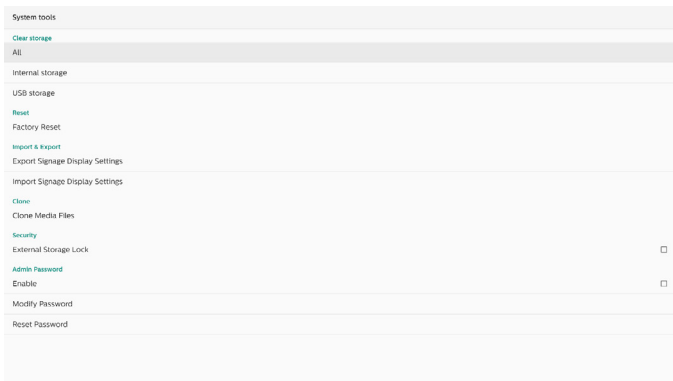

**Clear Storage**

Settings -> Signage Display -> System Tools -> Clear Storage



Clear the data under {storage}/philips/folder of the internal and external storage.

- (1).All  
Clear the folder "Philips" from the internal storage and USB.
- (2).Internal Storage  
Clear the folder "Philips" from the internal storage only.
- (3).USB Storage  
Clear the folder "Philips" from the USB storage only.

A dialog box lists all the folders that the system is going to clear. Press "RESET" to clear all data under the listed folder, or press the back key to quit without saving.

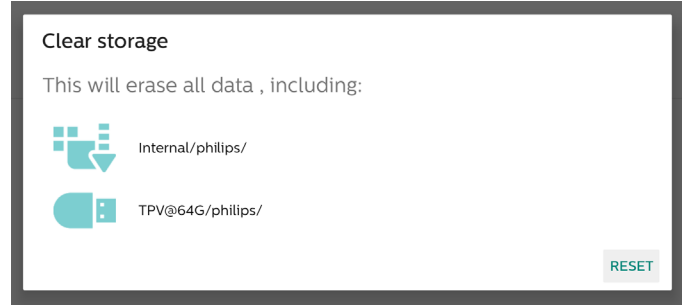

**Reset**

Settings -> Signage Display -> System Tools -> Reset



**Factory Reset**

This function allows you to clear all user data and settings. The system will auto reboot and jump to OOBE after rebooting.

**Important Note:**

1. Only the data stored in the internal storage will be cleared and cannot be recovered, the data includes the device settings, installed APPs, APPs' data, downloaded files, music, photos and all data under"/data". However, the data stored on the USB will not be cleared.
2. Make sure that the AC adapter and power are always present during the factory reset process. User can only power off after seeing OOBE on the screen.



Click "Factory Reset" to perform factory reset. Press "OK" to confirm when the dialog box appears. Please note this action clears all data in the internal storage and it is not recoverable.



**Import & Export**

Settings -> Signage Display -> System Tools -> Import & Export



This function allows you to import/export the settings and 3rd party APK from/to other device. Please note that:

- (1).Export data to BDL4650D-clone.zip file under {storage}/philips/clone folder.
- (2).Support old clone files method, and put files under {storage}/philips/sys\_backup:  
 AndroidPDMediaPlayerData.db  
 AndroidPDPdfData.db  
 menu\_settings.db  
 settings\_global.xml  
 settings\_secure.xml  
 settings\_system.xml  
 signage\_settings.db

Note that the latest export data will archive all files into a ZIP file.

(3). "Signage Display Name" will not be imported/ exported.

### Export Signage Display Settings

System exports database data and third party APKs into {storage}/philips/clone/BDL4650D-clone.zip file of the selected storage (internal storage, USB storage).

Note:

If the selected storage (internal storage, USB external storage) does not contain Philips/folder, then the system will create it automatically.

A list of all available storage (internal storage and USB storage):

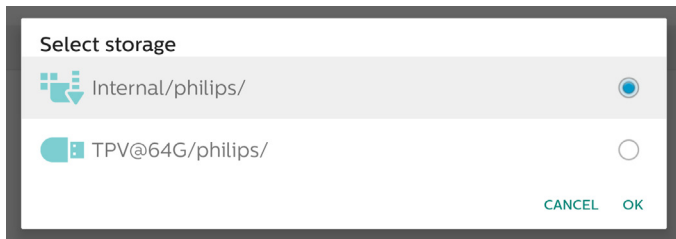

### Import Signage Display Settings

Import database data from philips/clone/BDL4650D-clone.zip file of the selected storage (internal Storage or USB storage). System imports following data in ZIP file:

- (1). Import Database in BDL4650D-clone.zip
- (2). Import 3<sup>rd</sup> party APK in BDL4650D\_clone.zip

A list of all available storage (internal storage and USB storage):

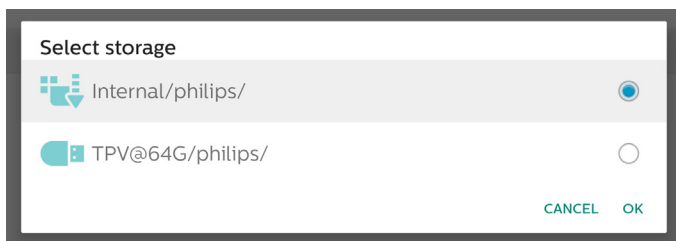

A confirmation dialog box is displayed before importing the settings and APKs. Click the "OK" button to start importing the data.

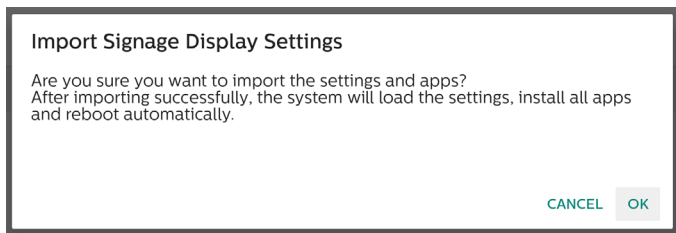

### Clone

Settings -> Signage Display -> System Tools -> Clone

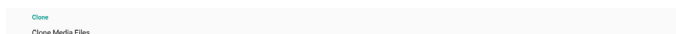

### Clone Media Files

This function allows you to copy the media files from the selected source storage to the target storage.

System clone files are located in the following folder:

- philips/photo
- philips/music
- philips/video
- philips/pdf
- philips/browser

### Security

Settings -> Signage Display -> System tools -> Security

#### External Storage Lock

Click the checkbox to lock or unlock external storage (USB storage). Default is unlocked.

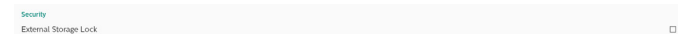

Note:

When you disable the external storage lock to enable state, please unplug and plugin the external storage again (for USB storage). After that, system can detect external storage again.

#### Admin Password

Settings -> Signage Display -> System tools -> Admin Password.

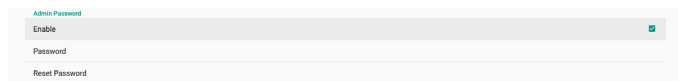

Enable:

Click the checkbox to enable or disable Admin Password. Default is disable.

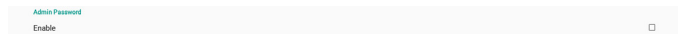

Once it is enabled, you will need a password to login in to Admin mode. Default password is "1234".

Password:

Settings -> Signage Display -> System tools -> Admin Password -> Password

You could change the password if you need a password for logging into Admin Mode. Follow the steps below:

(1). Enter your current password first. The default password is "1234".



If the current password is not correct, you will see an Android Toast "Incorrect password" message.



(2). Enter the new password.



(3).Enter the new password again.



If the new password again does not match the new password, you need to try again.



If the password is changed successfully, you will see an Android Toast "Successful" message.

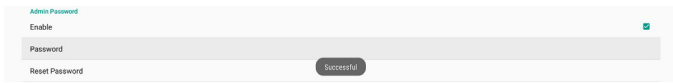

**Reset Password:**

Settings -> Signage Display -> System tools -> Admin Password -> Reset Password.

Reset the password to its default value, "1234". If the reset is successful, it will display a message that reads "Successful."



**6.1.3.6. Misc.**

**TeamViewer Support**

Click the checkbox to enable or disable the TeamViewer support. TeamViewer will send a virtual HOME key to open Admin mode. Default is enable.

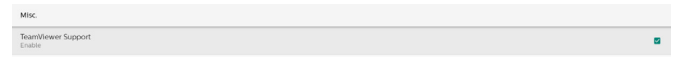

TeamViewerHost and TeamViewerQSAddOn APKs will be installed to the system automatically. Or, system will remove them if "TeamViewer Support" is disabled.

The following two APKs will be listed in Settings->Apps if "TeamViewer support" is enabled.



**Enable logging**

Enable or disable logging via checkbox.

Once enabled, PD will start logging android logcat log, kernel message and save them to USB or internal storage automatically. The first priority is USB storage. If there are no connected USB devices on PD, all data will then be saved to the internal storage.

The saved path will be {root directory of USB storage}/ philips/Log/xxBDL4650D-Log-{ yyyy-MM-dd-HH-mm-ss }

Or

{root directory of internal storage}/ philips/Log/xxBDL4650D-Log-{ yyyy-MM-dd-HH-mm-ss }

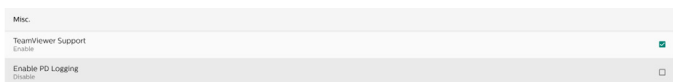

If disabling logging, all data will be saved to a zip file such as {root directory of USB storage}/ philips/Log/xxBDL4650D-Log-{ yyyy-MM-dd-HH-mm-ss }.zip

Or

{root directory of internal storage}/ philips/Log/xxBDL4650D-Log-{ yyyy-MM-dd-HH-mm-ss }.zip

**6.1.3.7. System updates**

**Local update**

Settings -> Signage Display -> System updates -> Local update

System will automatically search for "update.zip" in the root folder of the USB disk. If "update.zip" is found on the external storage, a list will be shown for user to select the file to update.

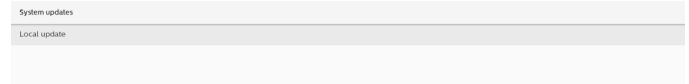

Once the file is selected from the list, the system starts rebooting and updating.

Please note that:

- (1). Do not turn off the power or remove the power adapter until the update is complete.
- (2). The current system only supports full Android update.
- (3). The update file must be named "update.zip" only.
- (4). The "update.zip" file must be stored in the root folder of your external storage.

**Remote update**

Settings -> Signage Display -> System updates -> Remote update

Please keep the network connected and available. Choose "Latest" or "Download code" to download the "update.zip" to root folder from Remote FW server. If you choose "Download code", you need to input 10 digits which you get from Remote FW server.

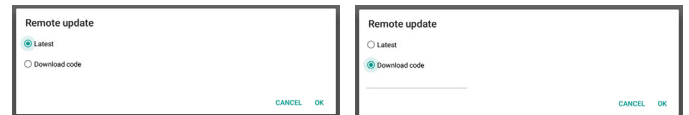
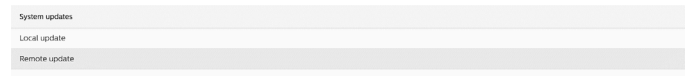

Click "OK", it may take about 5 minutes to download "update.zip" depending on the network speed. If the download is successful, the system will automatically transfer to the "Local update" process. The system will reboot and do the system update.

Please note that:

- (1). Keep the system powered on during the system update; do not remove the power adapter.
- (2). Currently, the system only supports a full Android update.

**6.1.3.8. Scaler FW updates**

**Start update**

Settings -> Signage Display -> Scaler FW updates -> Start update

Only the USB port near the Ethernet port can support scaler firmware update.

System will automatically search "{panel size}\_4650D.bin" in the root folder of the USB disk.

The prefix of the filename for the panel size must match the panel size of the platform.

For example, in 98BDL4650D platform, only 98\_4650D.bin can be accepted.

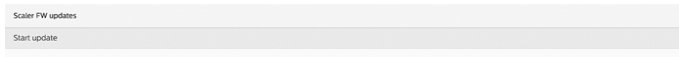

Please note that:

Keep the system power on during Scaler FW update, do not remove the power adapter.

## 6.1.4. Apps

Display information about installed APKs.

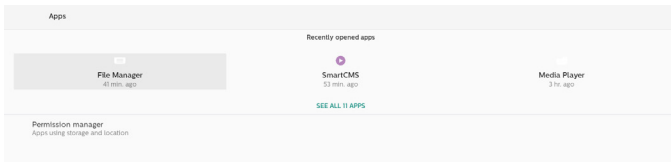

### 6.1.4.1. App info

All installed Android APP are listed. User can manage each APP's permission and other settings.

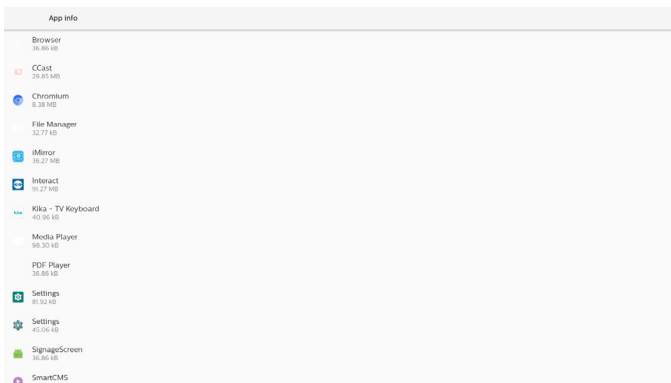

### 6.1.4.2. App permissions

List of major permission of the Android system and the APP that has permission to control it.

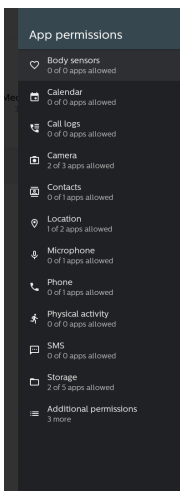

## 6.1.5. Security

Settings->Security

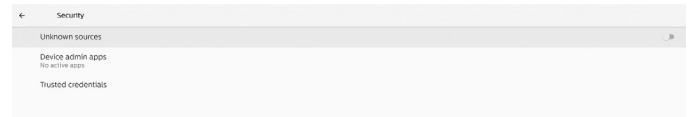

### 6.1.5.1. Unknown sources

Allowing app installs from Unknown Sources in Android.

### 6.1.5.2. Device admin apps

A list showing the app that supports admin-related operations and controls.

### 6.1.5.3. Trusted credentials

This will display a list of all trusted credentials on the device.

## 6.1.6. Accessibility

Accessibility services are apps that can help users with disabilities or special needs to interact with their Android device more easily.

In the Downloaded apps menu, you can view all the accessibility apps that are installed on the device, and enable or disable them as needed. You can also access the settings for each individual accessibility app by tapping on its name in the list.

## 6.1.7. System

The following options are listed in Settings -> System.

- (1). Keyboards
- (2). Date & time
- (3). Developer options

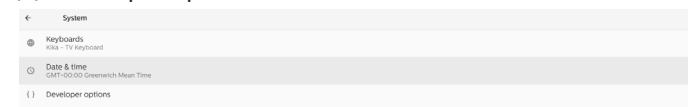

### 6.1.7.1. Keyboards

Settings -> System -> Keyboards

User can change IME and keyboard settings.

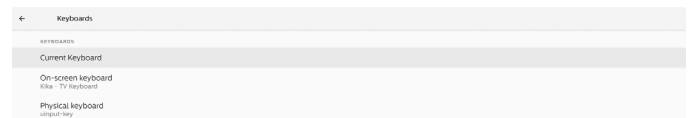

### Current Keyboard

Choose input method.

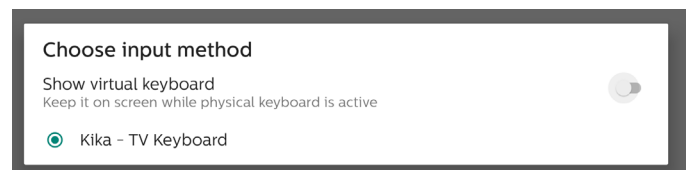

## On-screen keyboard

Let user set default software IME (Virtual keyboard) and control detailed IME settings.

The Japanese IME will automatically be installed when user selects Japanese language in OOB.E.



## Physical keyboard

Allow user to control physical keyboard and detailed keyboard settings.

The "TPV Vir-IR" is a system-level virtual keyboard that always exists on the keyboard list.

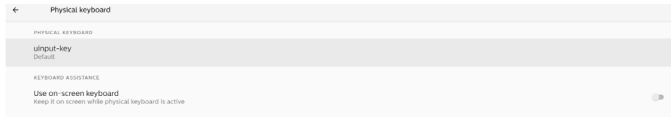

## 6.1.7.2. Date & Time

Settings -> System -> Date & Time

User can change the time zone and NTP server.

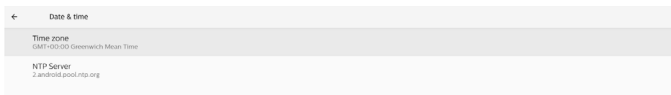

## Time zone

Allow user to choose the time zone.

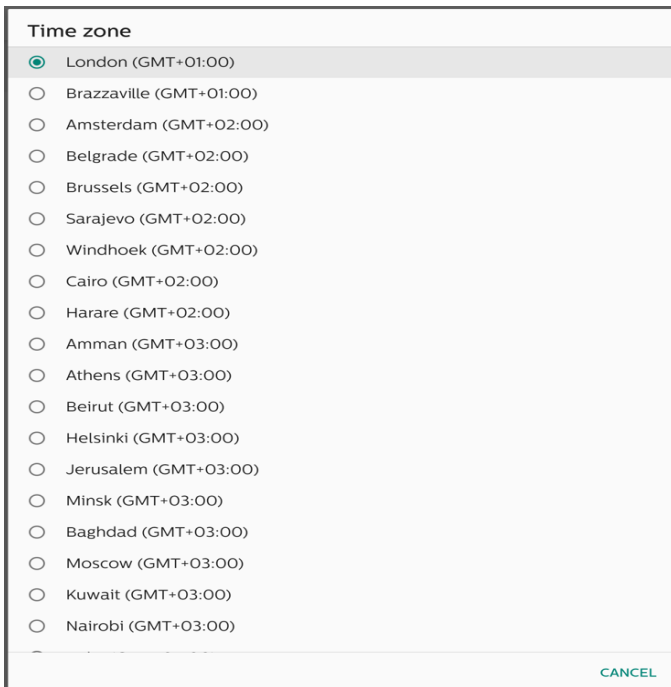

## NTP Server

Allow user to edit the NTP server in the prompted dialog.

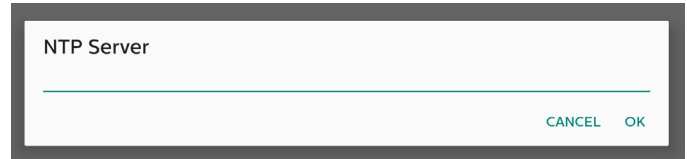

## Developer options

Settings -> System -> Developer options

Android developer options for developers, default is on and USB debugging is on by default.

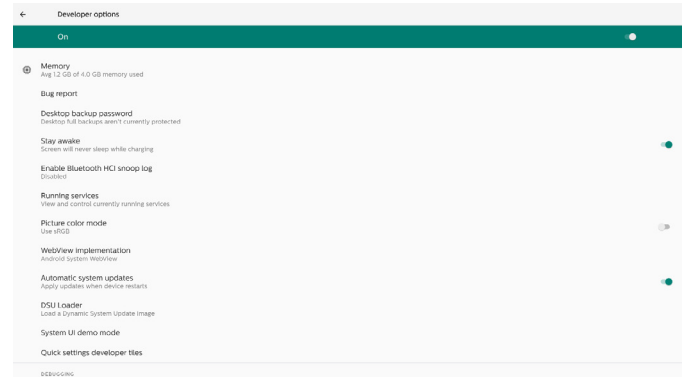

## 6.1.8. About

Settings -> About

View the following information about the system.

- (1).Legal information
- (2).Model (model name of this device)
- (3).Android version
- (4).Build number (release version)

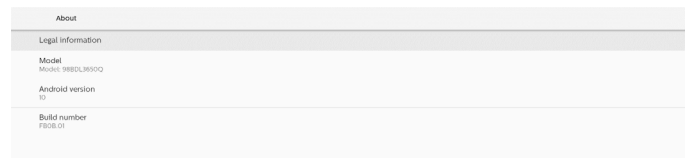

## 6.1.8.1. Legal Information

Legal information and licenses of all open source projects will be listed.

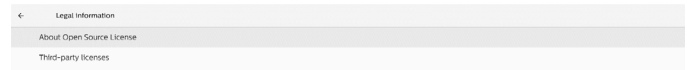

## 6.1.8.2. Model

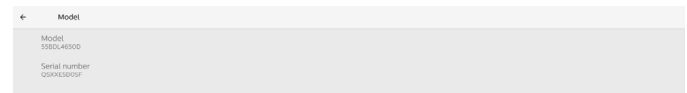

## 6.1.8.3. Android version





## 6.2. Supplementary

### 6.2.1. Quick Info

Press "Info + 77" to startup quick info.

Quick info will show "Network" and "Monitor Information".

Note:

Operation hours: updates every minute.

Heat status : updates every 5 seconds.

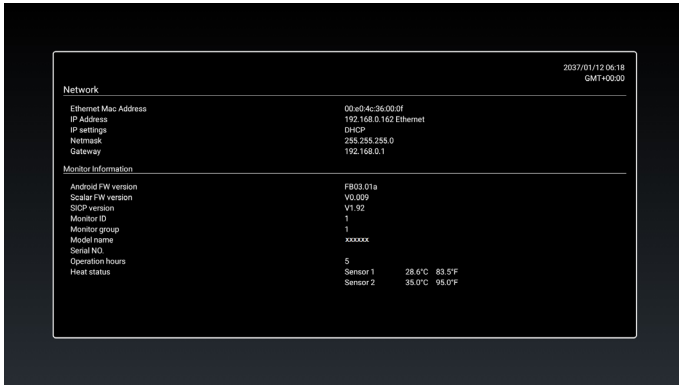

### 6.2.2. How to custom an Android boot animation?

#### 1. Overview

The Android boot animation is a script used to load PNG files when the device boots. It is included in an uncompressed zip file called bootanimation.zip.

#### 2. In the bootanimation.zip file

The bootanimation.zip as follows:

- The image folder (contains PNG images named in incremental numbers)
- The desc.txt file

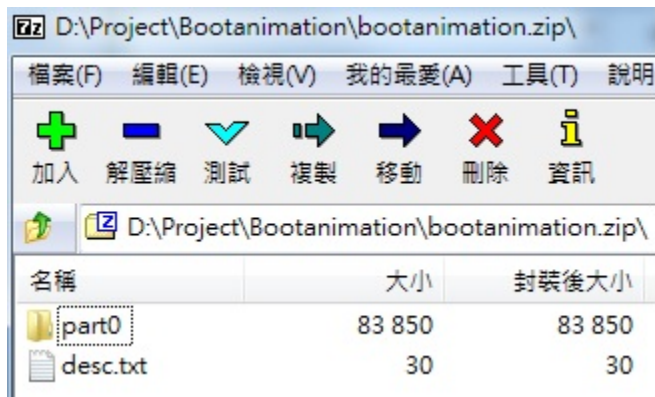

#### (1) The image folder

This folder contains PNG images that are named by numbers, starting from something like 0000.png or 0001.png and increasing by increments of 1. The minimum number of folder is 1 and the maximum number of folder is unlimited.

#### (2) The desc.txt file

This file defines how the images in the folder(s) are displayed during the boot animation, in the following format:

- Width Height Frame-rate

- mode Loop delay-time Folder1
- mode Loop delay-time Folder2

An example of a desc.txt file is:

- 1920 1080 30
- p 1 0 part0
- p 0 0 part1

#### a. The first line

1920 and 1080 define the width and height of the screen resolution.

30 is the frame rate in fps (frames per second) i.e. number of images to display per second.

#### b. The second and third lines have a same format.

The first "p" means that the play mode stops immediately when the boot process is complete.

The number next to 'p' defines the repeat mode

- Set to 0 to make the part loop indefinitely until the device boot is complete.
- Set to 1 to make the part playback for once.

The next number defines the delay time(ms). For example, if it is set to 10, the system will be delayed for 10ms when all image files have finished playing.

Part0 and part1 refer to image folder names.

As to the above example, the boot animation will play at a resolution of 1920 by 1080 pixels, at a frame rate of 30 fps, starting with the contents of part0 folder. After playing them in one loop, switch to the contents of part1 folder and play them continuously until the device boot process is complete.

#### 3. Zip file:

Select all (including image folders and desc.txt) inside the Bootanimation folder and zip them into a new uncompressed zip archive using your favorite compression utility such as 7zip or WinRAR and so on.

If using 7zip, set compression level to "Store".

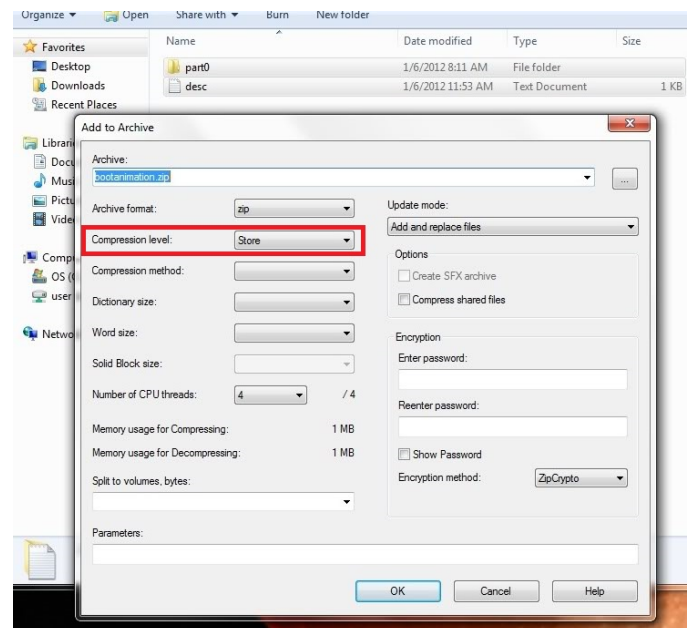

If using WinRAR, set "Compression method" to "Store".

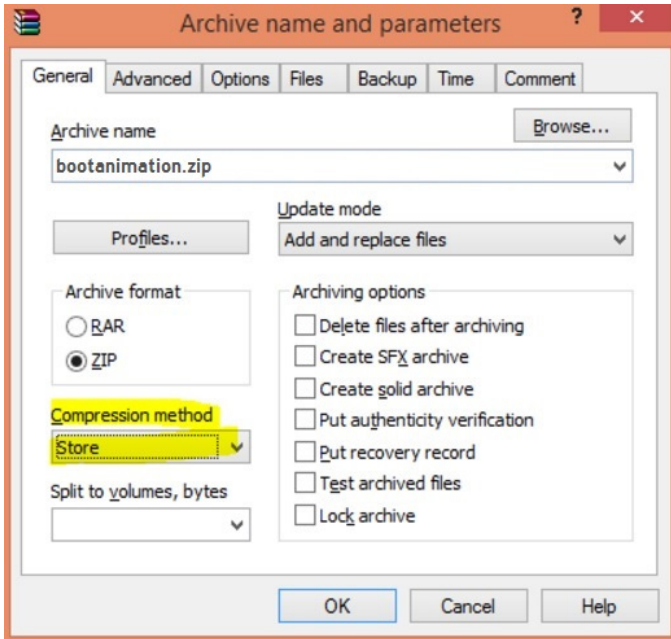

or bootanimation WON'T work.

#### 4. Apply the custom bootanimation

Procedure:

- (1) Place your custom bootanimztion.zip file into the external USB and plug the storage device into Phillips PD platform.
- (2) Make sure that the Logo option is enabled.  
Press the Home key on the RCU: OSD menu > Configuration 2 > Logo > set "on"
- (3) Press the combination key "Home + 1888" on the RCU to go to Admin mode:  
Settings > Signage Display > GENERAL SETTINGS > Boot Logo
- (4) The system will search the bootanimation.zip on the external USB automatically and copy it to /data/local
- (5) Once the step 1~4 are complete, restart the system. The new customized boot animation should be displayed during boot time.

### 6.2.3. How to Install Android app?

There are 3 ways to install your own Android App.

#### (a) Via File Manager in Admin Mode

1. If you have apk already
  - 1.1 Copy your APK to the USB disk, and plug the storage device into Philips Android Signage Display.
  - 1.2 Go to Admin Mode > Apps > File Manager
  - 1.3 Use File Manager to find your APK to be installed. Simply press "OK" on the selected APK.
2. Download an APK using the Chromium browser, then go to <internal storage path>/Download/ by File Manager.
  - 2.1 The next steps are the same as described above. Please note, each model may have different <internal storage path>.

#### (b) Via Adb Shell

1. Make sure that your PC can connect to Philips Android Signage Display using adb.

2. Prepare your apk in a folder (for example, C:\apkfolder) on your PC.

3. Execute the following instruction using command line tool.

```
C:\apkfolder> adb install -r apk_name.apk
```

#### (c) Via Customized Intent

1. If you develop an apk that can download any Android App, then your APK can issue a customized intent.
2. Giving that the apk name and the path have been stored., the system will help you to install by program.

Description	Intent	Parameters	
Sw Update	php.intent.action.UPDATE_APK	filePath	The absolute file path including the file name. Please make sure that the file access permission is 664 at least.
		keep	Indicate that you want to keep the file or not after updating. The default value is false.
		packageName	The target package you want to launch automatically after updating.
		activityName	The target activity you want to launch automatically after updating. But if current top activity is not activityName, nothing happened.
		isAllowDowngrade	"true: update apk no matter the version of target apk is lower than the verion of current one or not. false: stop install if it is downgrade."

For example,

```
Intent intent = new Intent();
intent.setAction("php.intent.action.UPDATE_APK");
intent.putExtra("filePath", "/Download/sample.apk");
intent.putExtra("keep", true);
intent.putExtra("packageName", "com.tpv.example");
intent.putExtra("activityName", "com.tpv.example.MainActivity");
intent.putExtra("isAllowDowngrade", true); // allow downgrade
sendBroadcast(intent);
```



## 7. OSD Menu

An overview of the On-Screen Display (OSD) structure is shown below. You can use it as a reference for further adjustment of your display.

### 7.1. Navigating the OSD Menu

#### 7.1.1. Navigating the OSD menu using the remote control

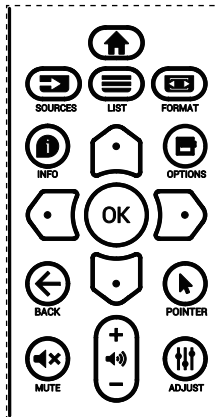

1. Press [HOME] button on the remote control to display the OSD menu.
2. Press [RIGHT] or [LEFT] button to select the item to adjust.
3. Press [OK] or [DOWN] button to enter the submenu.
4. In the submenu, press [RIGHT] or [LEFT] button to toggle between items, press [RIGHT] or [LEFT] button to adjust the settings. If there is a submenu, press [OK] or [DOWN] button to enter the submenu.
5. Press [LEFT] button to return to the previous menu, or press [HOME] button to exit from the OSD menu.

#### NOTES:

- When the OSD menu is not on the screen and input source is DisplayPort / VGA / DVI-I / HDMI1 / HDMI2, press [RIGHT] to display the menu of {Smart picture}.
- When the OSD menu is not on the screen and input source is DisplayPort / VGA / DVI-I / HDMI1 / HDMI2, press [LEFT] to display the menu of {Audio source}.

#### 7.1.2. Navigating the OSD menu using the display's control buttons

1. Press [MENU] button to display the OSD menu.
2. Press [+] or [-] button to select the item to adjust.
3. Press [+] button to enter the submenu.
4. In the submenu, press [▲] or [▼] button to toggle between items, press [+] or [-] button to adjust settings. If there is a submenu, press [+] button to enter the submenu.
5. Press [MENU] button to return to the previous menu, or keep pressing [MENU] button to exit from the OSD menu.

## 7.2. OSD Menu Overview

### 7.2.1. Picture menu

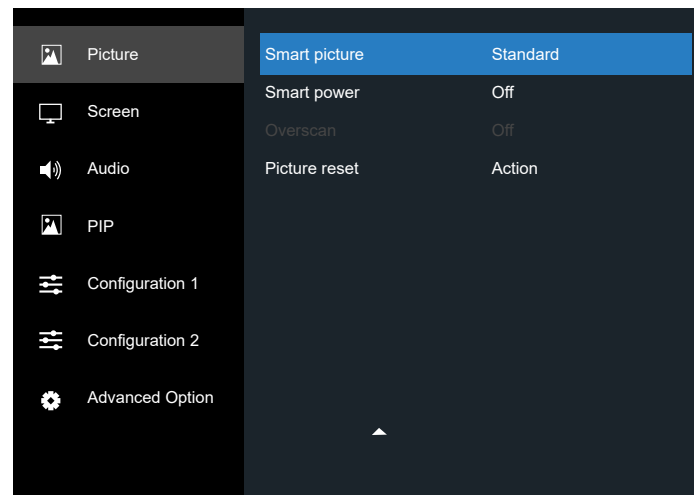
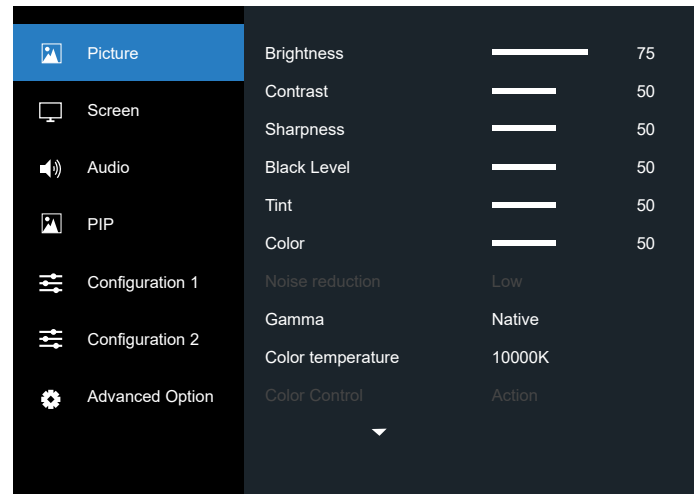

#### Brightness

Adjust the brightness of this display's backlight.

#### Contrast

Adjust the contrast ratio of the input signal.

#### Sharpness

Adjust the sharpness to improve the image detail.

#### Black level

Video black level is defined as the level of brightness at the darkest (black) part of a visual image. Adjust the black level of this display.

#### Tint

Adjust tint of the screen.

Press [RIGHT] button to make the tone color greenish. Press [LEFT] button to make the tone color purplish.

NOTE: This item applies to Video mode(YUV color space) only.

#### Color

Adjust the intensity of colors in the image.

NOTE: This item applies to Video mode(YUV color space) only.

## Noise reduction

Reduce picture noise. You can select a suitable noise reduction level.

The options are: {Off} / {Low} / {Medium} / {High}.

NOTE: This item applies to VGA input only.

## Gamma

Gamma is what controls the overall brightness of an image. Images which are not corrected properly can appear too white or too dark, so controlling the gamma properly can have a huge influence on the overall picture quality of your display.

The options are: {Native} / {2.2} / {2.4} / {S gamma} / {D-image}.

## Color temperature

Select a color temperature for the image. A lower color temperature will have a reddish tint, while a higher color temperature gives off a more bluish tint.

The options are: {3000K} / {4000K} / {5000K} / {6500K} / {7500K} / {9300K} / {10000K} / {Native} / {User 1} / {User 2}.

## Color control

You can adjust the color tones of the image precisely by changing the User-R (Red), User-G (Green) and User-B (Blue) settings independently.

{Picture} - {Color temperature} - {User} setting to [User 1]

Or, you can adjust the color tones per 100K in the range of 2000K to 10000K.

{Picture} - {Color temperature} - {User} setting to [User 2]

## Smart picture

The following smart picture modes are available for:

- PC mode: {Standard} / {Highbright} / {sRGB}.
- Video mode: {Standard} / {Highbright} / {Cinema}.

## Smart power

Set the display to reduce the power consumption automatically.

The options are: {Off} / {Medium} / {High}.

## Overscan

Change the display area of the image.

- {On} - Display about 95% of the original size of the image. The rest of the areas surrounding the image will be cut off.
- {Off} - Display the image in its original size.

## Picture reset

Reset all settings in the Picture menu.

## 7.2.2. Screen menu

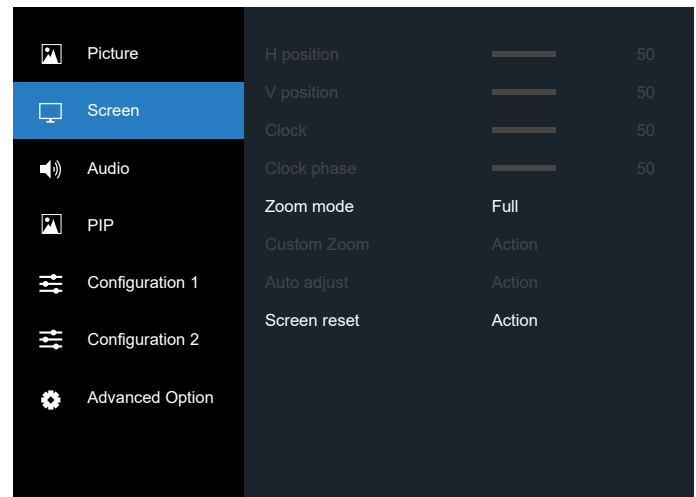

### H position

Press the [D] button to move the image to the right, or [C] to move the image to the left.

NOTES:

- H position adjustment applies to VGA input only.
- H position cannot be adjusted when {Pixel Shift} is activated.

### V position

Press the [D] button to move the image up, or [C] to move the image down.

NOTES:

- V position adjustment applies to VGA input only.
- V position cannot be adjusted when {Pixel Shift} is activated.

### Clock

Adjust the width of the image.

NOTE: This item applies to VGA input only.

### Clock phase

Adjust to improve the focus, clarity and stability of the image.

NOTE: This item applies to VGA input only.

### Zoom mode

The pictures you receive may be transmitted in 16:9 format (wide screen) or 4:3 format (conventional screen). The 16:9 pictures sometimes have a black band at the top and bottom of the screen (letterbox format). Zoom Mode will be deactivated when {SUB Mode} of {PIP} is turned on, and when {Tiling} is enabled.

Choose from: {Full} / {4:3} / {1:1} / {16:9} / {21:9} / {Custom}.



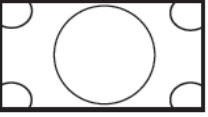
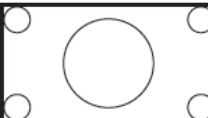
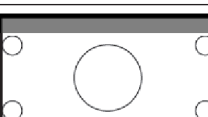

	<p><b>Full</b> This mode restores the correct proportions of pictures transmitted in 16:9 using the full screen display.</p>
	<p><b>4:3</b> The picture is reproduced in 4:3 format and a black band is displayed on either side of the picture.</p>

	<b>1:1</b> This mode displays the image pixel-by-pixel on screen without scaling the original image size.
	<b>16:9</b> The picture is reproduced in 16:9 format and a black band at the top and bottom.
	<b>21:9</b> The picture is reproduced in 21:9 format and a black band at the top and bottom.
	<b>Custom</b> Choose to apply the custom zoom settings in the Custom Zoom submenu.

### Custom zoom

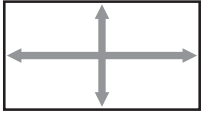
Use this function to further customize the zoom settings to suit the image you want to display.

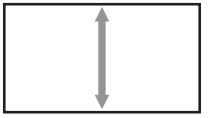
NOTE: This item works only when the {Zoom mode} is set to {Custom}.

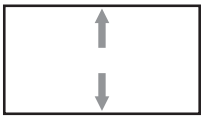
	<b>Zoom</b> Expands the horizontal and vertical sizes of image simultaneously.
	<b>H zoom</b> Expands the horizontal size of image only.
	<b>V zoom</b> Expands the vertical size of image only.
	<b>H position</b> Moves the horizontal position of image left or right.
	<b>V position</b> Moves the vertical position of image up or down.

### Auto adjust

Press "Set" to detect and adjust H position, V position, Clock, Phase automatically.

NOTE: This item applies to VGA input only.

### Screen reset

Reset all settings in the Screen menu to factory preset values.

## 7.2.3. Audio menu

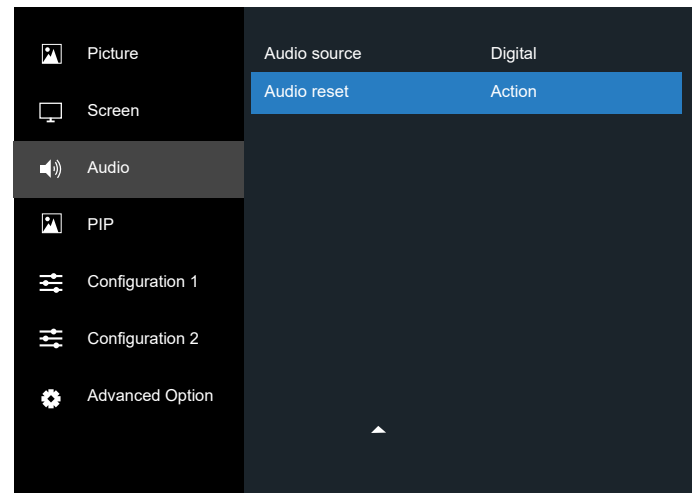
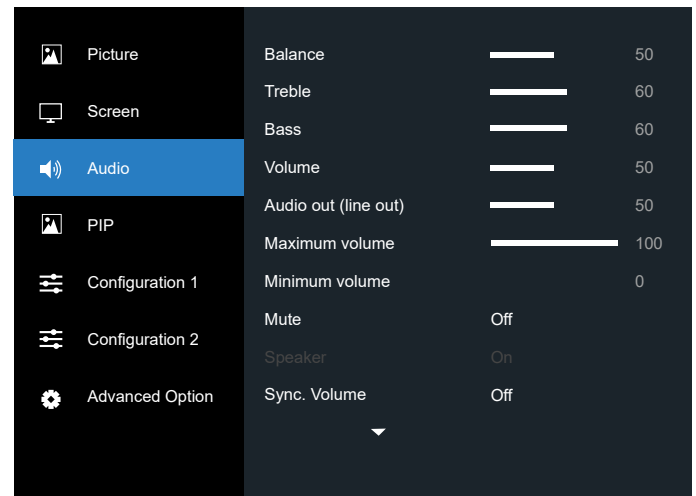

### Balance

Adjust to emphasize left or right audio output balance.

### Treble

Adjust to increase or decrease higher-pitched sounds.

### Bass

Adjust to increase or decrease lower-pitched sounds.

### Volume

Adjust the volume.

### Audio out (Line out)

Adjust to increase or decrease line out output level.

### Maximum volume

Adjust your own limitation for the maximum volume setting. This stops the volume at the sound level you set.

### Minimum volume

Adjust your own limitation for the minimum volume setting.

### Mute

Turn the mute function on/off.

### Speaker

Turn the internal speaker on/off.

NOTE: This function is only available when {Sync. Volume} is on.

**Sync. Volume**

Enable/disable audio out (line out) volume adjustability to sync with internal speakers volume, but PD Internal speaker sound will be forced to be mute.

**Audio source**

Select the audio input source.

Analog: audio from audio input

Displayport: audio from DP.

Digital : audio from HDMI/DVI audio.

Media : audio from Media Player / BROWSER / PDF Player / Custom / Interact

**Audio reset**

Reset all settings in the Audio menu to factory preset values.

**7.2.4. PIP menu**

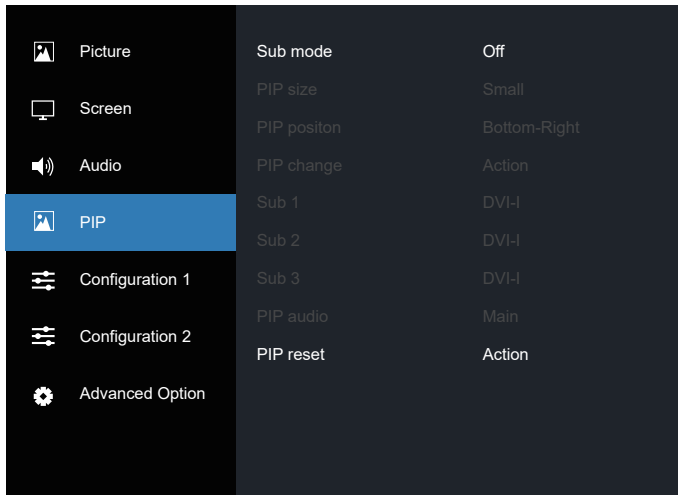

**Sub mode**

Select the PIP (Picture-in-Picture) mode.

The options are: {Off} / {PIP} / {Quick swap} / {PBP 2Win} / {PBP 4Win}/ {PBP 4Win-1}.

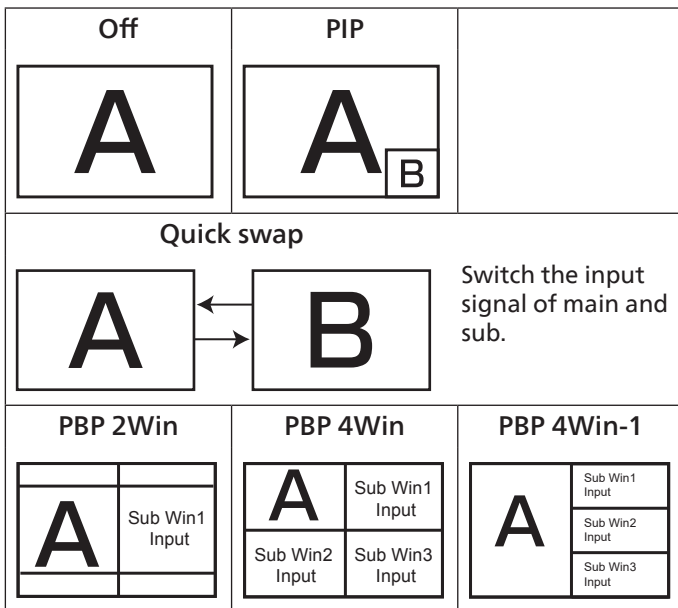

**PIP size**

Select the size of sub picture in PIP (Picture-in-Picture) mode.

The options are: {Small} / {Medium} / {Large}.

**PIP position**

Select the position of sub picture in PIP (Picture-in-Picture) mode.

The options are: {Top-Right} / {Top-Left} / {Bottom-Right} / {Bottom -Left} / {Center}.

**PIP change**

Switch the input signal of Main and Sub for PIP / Quick swap mode.

**Sub 1**

Select the input signal for the sub Win1 picture.

Choose from: {Displayport} / {DVI-I} / {VGA} / {HDMI1} / {HDMI2} / {Media Player} / {BROWSER} / {PDF Player} / {Custom} / {Interact}.

**Sub 2**

Select the input signal for the sub Win2 picture.

Choose from: {Displayport} / {DVI-I} / {VGA} / {HDMI1} / {HDMI2} / {Media Player} / {BROWSER} / {PDF Player} / {Custom} / {Interact}.

**Sub 3**

Select the input signal for the sub Win3 picture.

Choose from: {Displayport} / {DVI-I} / {VGA} / {HDMI1} / {HDMI2} / {Media Player} / {BROWSER} / {PDF Player} / {Custom} / {Interact}.

**PIP audio**

Select the audio source in PIP (Picture-in-Picture) mode.

- {Main} - Select audio from the main picture
- {Sub 1} - Select audio from the sub 1 picture.
- {Sub 2} - Select audio from the sub 2 picture.
- {Sub 3} - Select audio from the sub 3 picture.

**PIP reset**

Reset all settings in the PIP menu to factory preset values.

**NOTES:**

- The PIP function is available only under the following condition: {Advanced option} - {Tiling} - {Enable} setting to [No].
- The PIP function is available only for certain signal source combinations as shown in the table below.

Sub Mode \ Main Input										
	DP	VGA	DVI-I	HDMI1	HDMI2	Media Player	Browser	PDF Player	Custom	Interact
DP	O	O	O	O	O	O	O	O	O	O
VGA	O	O	O	O	O	O	O	O	O	O
DVI-I	O	O	O	O	O	O	O	O	O	O
HDMI1	O	O	O	O	O	O	O	O	O	O
HDMI2	O	O	O	O	O	O	O	O	O	O
Media Player	O	O	O	O	O	O	X	X	X	X
Browser	O	O	O	O	O	X	O	X	X	X
PDF Player	O	O	O	O	O	X	X	O	X	X
Custom	O	O	O	O	O	X	X	X	O	X
Interact	O	O	O	O	O	X	X	X	X	O

(O: PIP function is available, X: PIP function is unavailable)

- The availability of PIP function depends on the resolution of input signal being used.

## 7.2.5. Configuration1 menu

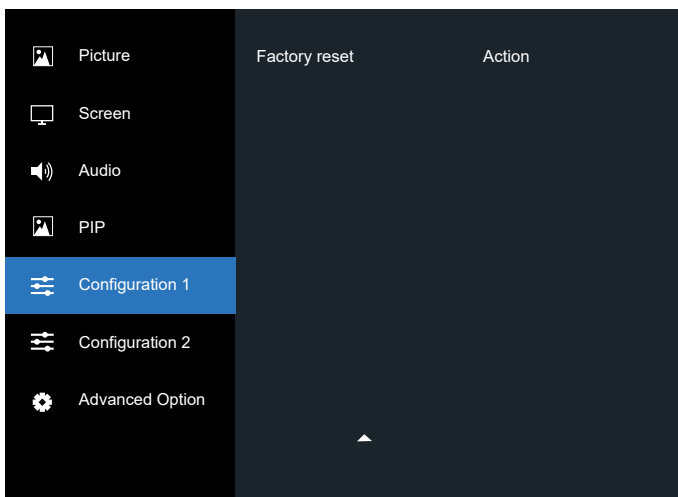
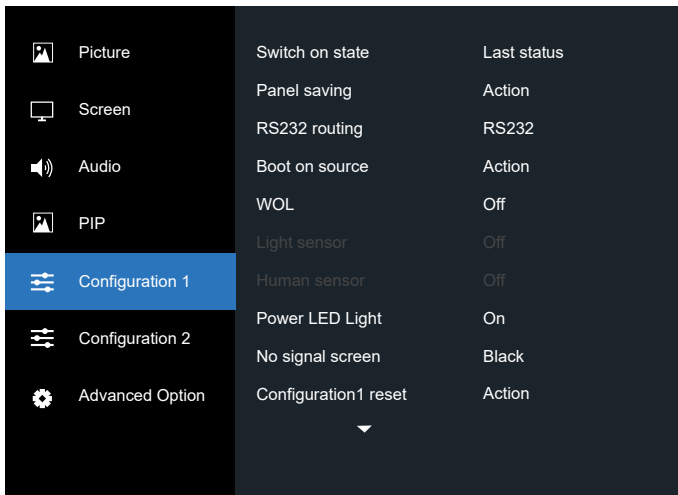

### Switch on state

Select the display status that will be applied when you connect the power cord next time.

- {Power off} - The display will remain off when the power cord is connected to a wall outlet.
- {Forced on} - The display will turn on when the power cord is connected to a wall outlet.
- {Last status} - The display will return to the previous power status (on/off/standby) when removing and replacing the power cord.

### Panel saving

Enable or disable the panel saving functions and thus reduce the risk of "image persistence" or "ghost-imaging".

- {Brightness} - Select {On} and the image brightness will be reduced to an appropriate level. The Brightness setting in the Picture menu will be unavailable when selected.
- {Pixel shift} - Select the time interval ({Auto} / {10 ~ 900} seconds / {Off}) for the display to slightly expand the image size and shift the position of pixels in four directions (up, down, left, or right). Activating Pixel Shift will disable H Position, V Position and Zoom Mode in the screen menu.

### RS232 routing

Select the network control port.

The options are: {RS232} / {LAN ->RS232}.

### Boot on source

Choose to select a source when boot up.

- Input: select input source when boot up.
- Playlist: select playlist index for Media player, Browser, PDF player.
- 0: no play list. Same as switching source from OSD.
- 1~7: playlist number.
- USB Autoplay: auto play option for Media Player.

### WOL

Choose to turn on or off the wake on LAN function.

Choose from : {Off} / { On}

### Light sensor (require Philips accessory CRD41 External Sensor Box)

Choose to turn on or off backlight adjustment according to environment brightness.

Choose from : {Off} / { On}

### Human sensor (require Philips accessory CRD41 External Sensor Box)

The Human sensor can detect if people approach the display or not.

The display will turn off backlight if it detects nothing in setting time.

The display will return to backlight on when people approach the display.

The options are: {Off} (Default), {10 Min.}, {20 Min.}, {30 Min.}, {40 Min.}, {50 Min.}, {60 Min.}

### Power LED Light

Choose to set power indication LED on or off.

Choose {On} for normal use.

### No signal screen

Choose to change background color of "no signal"

The option are:

- {Black} - Background color black, also display "no-signal" OSD.
- {Blue} - Background color blue, also display "no-signal" OSD.
- {Off} - Background color black, not display "no-signal" OSD.

### Configuration1 reset

Reset all settings in Configuration1 menu to the factory preset values.

### Factory reset

Reset all settings in the OSD menu of {Picture}, {Screen}, {Audio}, {PIP}, {Configuration1}, {Configuration2} and {Advanced option} to the factory preset values.

Press [↩] or [↪] button to select {Reset}, and press [OK] button to perform the reset.

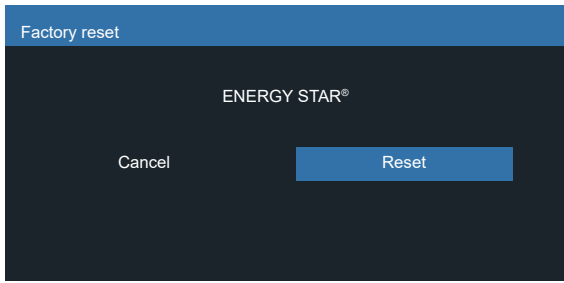

### 7.2.6. Configuration2 menu

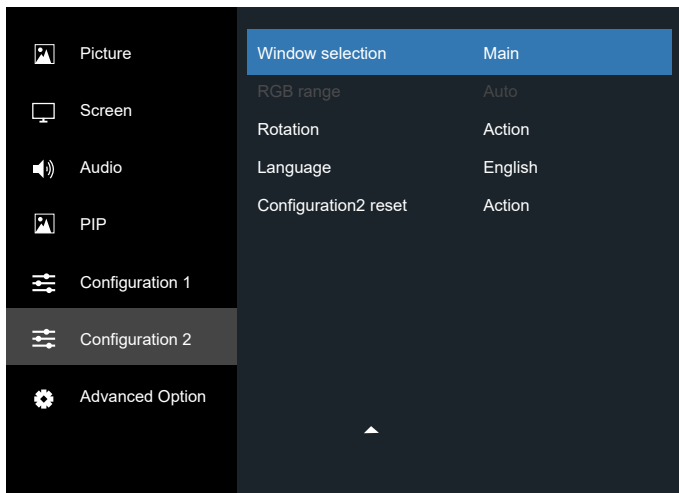
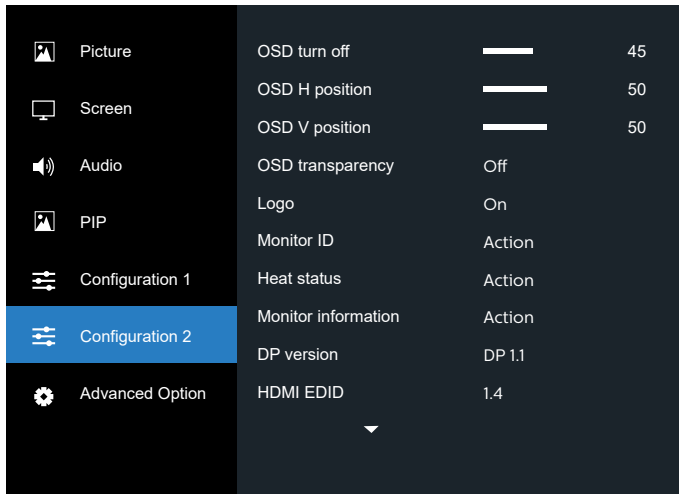

#### OSD turn off

Set the period of time the OSD (on-screen display) menu stays on the screen.

The options are: {0 ~ 120} seconds.

#### OSD H-position

Adjust the horizontal position of OSD menu.

#### OSD V-position

Adjust the vertical position of OSD menu.

#### OSD Transparency

Adjust OSD transparency.

- {Off} - Transparency off.
- 20/40/60/80/100.

#### Logo

Choose to enable or disable the picture of Logo when turning on your display.

The options are:

- {Off}
- {On}
- {User}

NOTE: If it is set to {USER}, the rotation function is not supported for user logo.

#### Monitor ID

Set ID number for controlling the display via the RS232C connection. Each display must have a unique ID number when multiple sets of display are connected. Monitor ID number range is between 1 to 255.

The option are: {Monitor group} / {Tiling matrix} / {Auto ID}

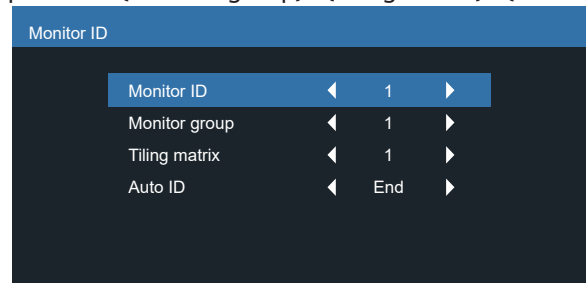

- {Monitor group}

The options are: {1-255}. The default setting is 1.

- {Tiling matrix}

Tiling matrix number range is between 1 to 15. 1 is the default setting. The {Auto ID} setup function enables setting up {Monitor ID} of connected machine according to {Tiling matrix} settings.

Example: Tiling matrix sets to 4

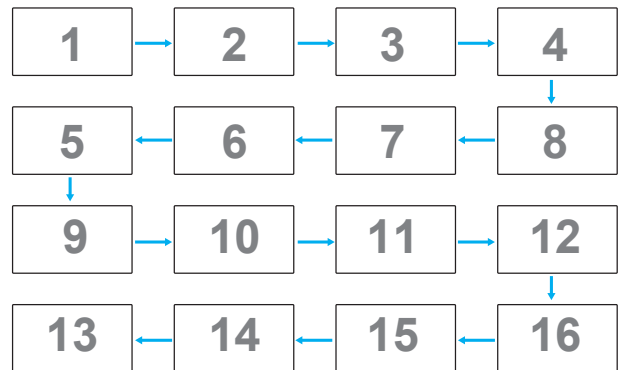

- {Auto ID}

The option are: {Start} / {End}. The default setting is {End}.

- Switch to Start to set up the IDs of machines backward from current one.
- Once the setup is completed, the option exits from End automatically.
- To use this function, serially connect all machines with RS-232 cable and set their Control ports to RS-232 too.

#### Heat status

This function allows you to check the thermal status of display at any time.



## Monitor information

Show information about your display, including model number, serial number, operating hours and software version.

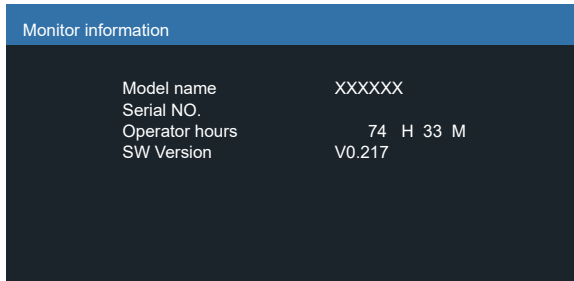

## DP Version

The options are: {DP 1.1} / {DP 1.2}. The default setting is {DP 1.1}.

## HDMI edid

The option are: {HDMI 1.4} / {HDMI 2.0}. The default setting is {HDMI 1.4}.

NOTE: HDMI 2.0 option is to support HDMI 2.0 equipment.

## Window selection

Select the window for adjusting the settings. The selected window will be highlighted with green frame.

The options are: {Main}(Default), {Sub 1}, {Sub 2}, {Sub 3}.

## RGB Range

The options are: {Auto} / {Full (PC)} / {Limited (Video)} The default setting is {Auto}.

## Rotation

Set the rotation of Main/Sub/OSD

- Auto Rotate : Off/On,Default : Off  
Auto Rotate: {Off}, {On} when value is On,automatically detect whether the PD rotation, Off is set by OSD.
- OSD Rotate : Landscape/Portrait,Default : Landscape  
OSD Rotate: {Off}, {On} when value is on, OSD rotate 270 °, Off is restored.
- Image rotation: Off/On,Default : Off  
Image rotation: {Off}, {On} when value is on, all Window screen with the support input source\* rotate 270 °, Off is restored

Support input source: Media Player / BROWSER / PDF Player / Custom / Interact

NOTE: When the Main / Sub1(2/3) in PIP/PBP mode is one of the support input source, the rotation is given priority to the last setting.

## Language

Select the language used in the OSD menu.

The options are: English/Français/Deutsch/Español/Italiano/ 简体中文 / 繁體中文 / Português / 日本語 / Polski / Türkçe / Русский / العربية / Danish / Svenska / Suomi / Norsk / Nederlands / Čeština / Eesti / Latviešu / Lietuvių.

## Configuration2 reset

Reset all settings in Configuration2 menu to the factory preset values.

## 7.2.7. Advanced option menu

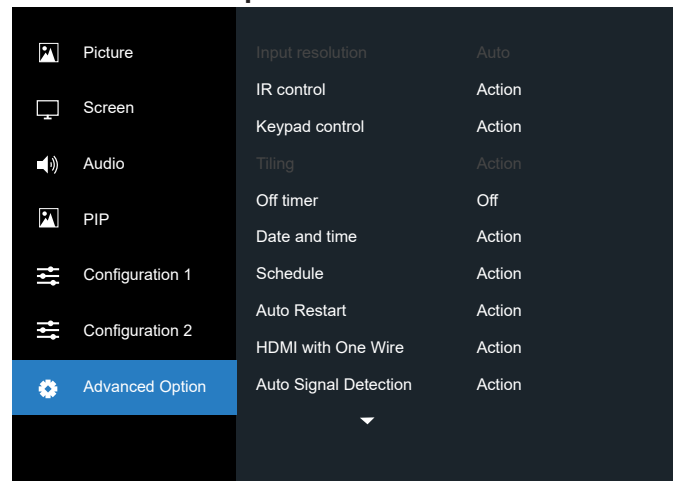

### Input resolution

Set the resolution of VGA input. This is only required when the display is unable to detect the VGA input resolution correctly.

NOTE: This item applies to VGA input only.

The options are:

- {1024x768 / 1280x768 / 1360x768 / 1366x768}
- {1400x1050 / 1680x1050}
- {1600x1200 / 1920x1200}
- {Auto}: Determines the resolution automatically.

The selected settings will become effective after turning off the power and turning it on again.

### IR control

Select the operation mode of remote control when multiple displays are connected via an RS232C connection.

- {Normal} - All displays can be operated normally by the remote control unit.
- {Primary} - Designate this display as the primary display for remote control operation. Only this display can be operated by the remote control.
- {Secondary} - Designate this display as the secondary display. This display can not be operated by the remote control, and will only receive the control signal from the primary display via the RS232C connection.
- {Lock All} / {Lock all but Volume} / {Lock all but Power} / {Lock all except PWR & VOL}- Lock the remote control function of this display. To unlock, press and hold the [INFO] button on the remote control for 5 (five) seconds.

NOTE:

1. [Hot key] Hot key to display the Primary / Secondary OSD
2. Press [Left] or [Right] button to display the Primary / Secondary OSD in the case of DisplayPort / VGA / DVI-I / HDMI1 / HDMI2 and no OSD display.
3. In the Primary OSD, press [Left] or [Right] button to adjust the value of {Control Monitor ID}, and press [Up] or [Down] button to adjust the value of {Control Group ID}.

### Keypad Control

Select to enable or disable the display keyboard (control buttons) function.

- {Unlock} - Enable the keyboard function.

- {Lock All} / {Lock all but Volume} / {Lock all but Power} / {Lock all except PWR & VOL} - Disable the keyboard function.

NOTE: To enable or disable the keyboard control lock, press [F4] and [F5] buttons simultaneously and keep pressing continuously for more than 3 seconds.

**Tiling**

With this function you can create a single large-screen matrix (video wall) that consists of up to 225 sets of this display (up to 15-sets on the vertical and 15-sets on the horizontal sides). This function requires a daisy-chain connection.

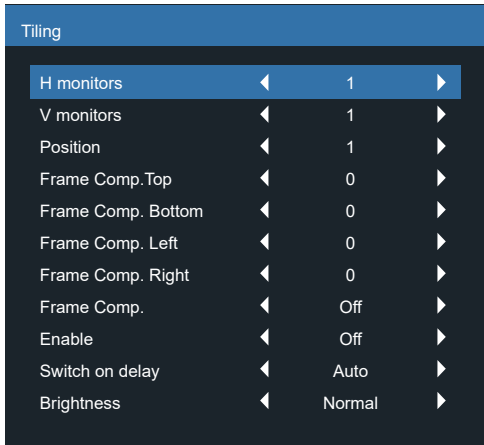

Example: 2 x 2 screen matrix (4 displays)

H monitors = 2 displays  
V monitors = 2 displays

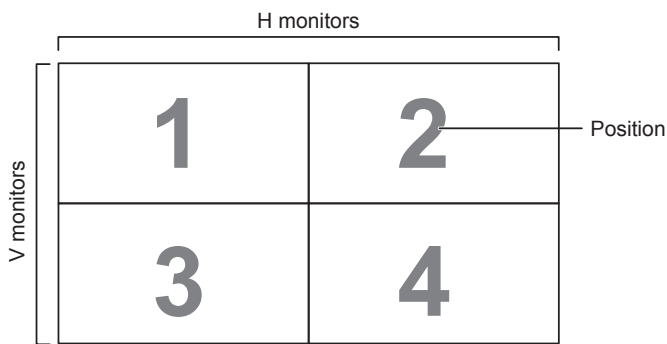

Example: 5 x 5 screen matrix (25 displays)

H monitors = 5 displays  
V monitors = 5 displays

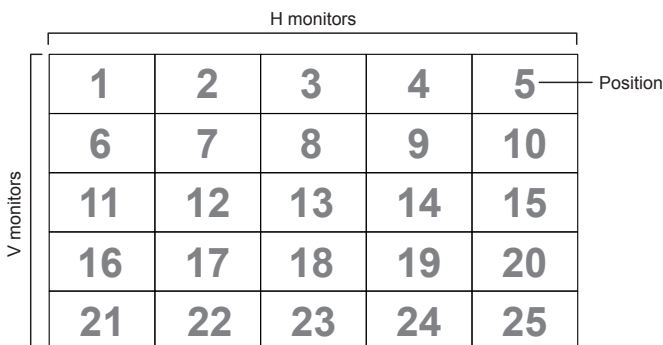

- {H monitors} - Select the number of displays on the horizontal side.
- {V monitors} - Select the number of displays on the vertical side.

- {Position} - Select the position of this display in the screen matrix.
- {Frame comp. Top} - set the pixel numbers of top frame compensation.
- {Frame comp. Bottom} - set the pixel numbers of bottom frame compensation.
- {Frame comp. Left} - set the pixel numbers of left frame compensation.
- {Frame comp. Right} - set the pixel numbers of right frame.
- {Frame comp.} - Choose to turn the frame compensation function on or off. If selected {Yes}, the display will adjust the image to compensate for the width of the display bezels in order to accurately display the image.
- {Enable} - Choose to enable or disable the Tiling function. If enabled, the display will apply the settings in {H monitors}, {V monitors}, {Position}, and {Frame comp.}.
- {Switch on delay} - Set the power-on delaying time (in seconds). The default option {Auto} allows a sequential powering-on for each display by their ID number when multiple displays are connected. The options are: {Off/ Auto/2-255}.

- Brightness: {Normal}/{ACS}

{Normal}: Apply OSD brightness value (backlight).

{ACS}: Apply brightness value (backlight) which is adjusted by MIC tool. The default value before adjustment is the same as OSD brightness value, e.g., 70).

Some brightness (backlight) settings cannot be adjusted by OSD. Please refer to Picture Menu Backlight setting priority.

**Off Timer**

Set the display to turn itself off to standby mode within a specified period of time.

The options are: {Off, 1 ~ 24} hours from current time.

NOTE: When the "Off timer" is activated, the "Schedule" settings will be disabled.

**Date and time**

Adjust the current date and time for the display's internal clock.

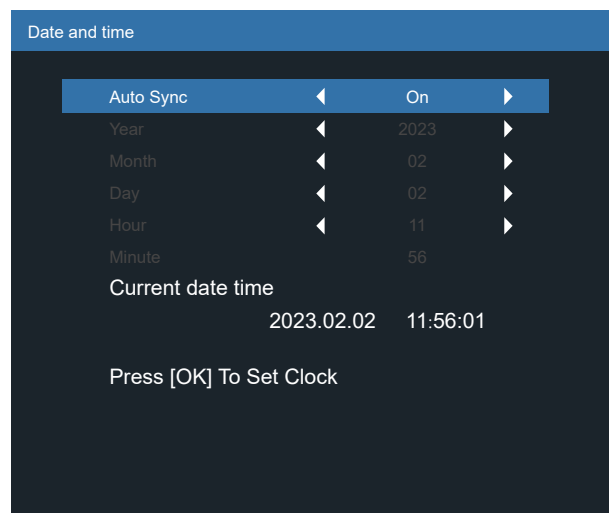

1. Press [OK] button to enter or make a selection.
  2. Press [←] back button to return.
  3. Press [F4] or [F5] button to adjust the settings.
- \* Cannot set the time to any date after the year 2037.



## Schedule

This function allows you to program up to 7 (seven) different scheduled time intervals for the display to activate.

You can select:

- The time for the display to turn on and turn off.
- The days in a week for the display to activate.
- Which input source the display will use for each scheduled activation period.

**NOTE:** It is recommended that you set up the current date and time in the {Date and time} menu before using this function.

1. Press [OK] or [D] button to enter the submenu.

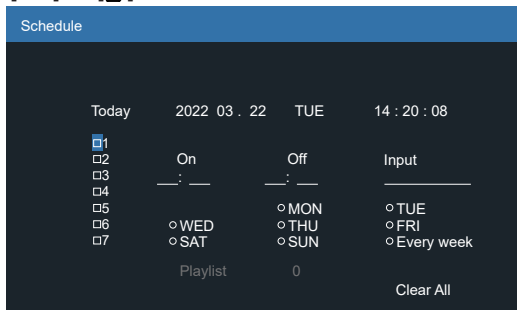

2. Press [△] or [▽] button to select a schedule item (item number 1 ~ 7), and press [OK] button to mark the item number.

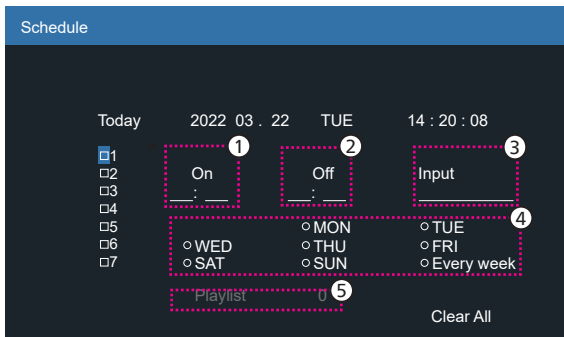

3. Press [△] or [▽] button to select the schedule:
  - ① Power-on schedule: Press [△] or [▽] button to adjust and the display will turn on at the specified time.
  - ② Power-off schedule: Press [△] or [▽] button to adjust and the display will turn off at the specified time.

Leave the hour and minute options empty if you do not want to use the function of power-on or power-off schedule.

- ③ Input-source selection: Press [△] or [▽] button to select an input source. If no input source is selected, the input source will remain the same as the previous one.
  - ④ Date schedule: Press [D] button to select which day in a week this schedule item will take effect, then press the [OK] button.
  - ⑤ When Input-source select to Media player, Browser or PDF player, enable to access playlist setting.
4. For additional schedule settings, press [←], then repeat the steps above. A check mark in the box next to the number of the schedule item indicates that the selected schedule is in effect.

## NOTES:

- If the schedules overlap, the scheduled power-on time takes priority over scheduled power-off time.
- If there are two schedule items programmed for the same time, the highest numbered schedule takes priority. For example, if schedule items #1 and #2 both set the display to power on at 7:00 AM and off at 5:00 PM, then only schedule item # 2 will take effect.

## Auto Restart

Define a specific time to restart Android every day

- {Auto Restart} - the option are: {Off} / {On},  
 {Off}: Auto restart is disabled  
 {On}: Auto restart is enabled
- {Hour} - Select the hour to restart Android.
- {Minute} - Select the minute to restart Android

## HDMI with One Wire

{HDMI With One Wire Power OFF} - CEC power off control for Player->PD (System Standby)

The option are: {Off} / {On},

- {Off}: Disable.
- {On}: Enable.

## NOTES:

System Standby enables users to switch multiple devices to standby mode with the press of one button (Player -> PD)

- Available if {HDMI with One Wire} is on.

## Auto signal detection

This function allows the system to detect and display the available signal sources automatically.

- {Off} - Once a signal is connected, it can only be selected manually.

If the selected input has no signal, set the system to display the image automatically according to the search order of each option.

The options are: {All} / {Failover}

- {All} - DP -> DVI-I -> VGA -> HDMI1 -> HDMI2 -> Media Player -> BROWSER -> PDF Player -> Custom -> Interact.
- {Failover} - Once a signal is connected, it can only be selected manually.
  - Failover 1-10: User-defined setting. Default: HDMI.

## Power Save

Power save modes

Mode 1: [TCP off, WOL on, auto off]

DC off -> Power off, Android(ARM) off, LED: Red.

Power Save -> Power off, Android(ARM) off, LED: Red

Mode 2: [TCP off, WOL on, auto on/off]

DC off -> Power off, Android(ARM) off, LED: Red.

Power Save -> Power Saving, Android(ARM) off, LED: Orange. Can be woken up.

Mode 3: [TCP on, WOL off, auto on/off]

DC off -> Back light off, Android(ARM) on, LED: Red

Power Save -> Back light off, Android(ARM) on, LED: Orange. Can be woken up.

Mode 4: [TCP on, WOL off, no auto on/off]

DC off -> Back light off, Android(ARM) on, LED: Red

Power Save -> Will not enter power save mode. It shows "no signal" only.

Mode 1(default) DC OFF: Power Off Android(ARM) Off Power Save: Power Off Android(ARM) Off	Mode 2 DC OFF: Power Off Android(ARM) Off Power Save: Power Saving Android(ARM) Off
Mode 3 DC OFF: Backlight Off only Android(ARM) On Power Save: Backlight Off only Android(ARM) On	Mode 4 DC OFF: Backlight Off only Android(ARM) On Power Save: No signal(Backlight On) Android(ARM) On

DC off/on: Press power button by RC

#### Scaler FW Update

Update scaler FW by USB.

NOTE: Only **USB 2.0 flash disk** is supported.

#### Information OSD

Set the period of time that the information OSD is displayed on the upper right corner of the screen. The information OSD will display when the input signal is changed.

The information OSD will remain on the screen with {Off} selection.

The options are: {Off, 1 ~ 60} seconds.

#### Advanced option reset

Reset all settings except {Date and Time} in the Advanced option menu to factory preset values.

1. Press [OK] or [D] button to enter the submenu.
2. Press [C] or [D] button to select {Reset} and press the [OK] button to restore settings to factory preset values.
3. Press the [←] button or select {Cancel} and press the [OK] button to cancel and return to the previous menu.

## 8. Supported Media Formats

### USB Multimedia Codec Formats

Video Decode						
Type	Video Codec	Container	Decode	Encode	Channel	Remark
MPEG1/2	MPEG1/2	MPEG program stream (.DAT, .VOB, .MPG, .MPEG) MPEG transport stream (.ts) MP4 (.mp4) AVI (.avi) MKV (.mkv)	V			Max Resolution: 1080P@60fps Max Bit Rats : 40Mbps
MPEG-4	MPEG4	MP4 (.mp4) AVI (.avi) MKV (.mkv)	V			Max Resolution: 1080P@60fps Max Bit Rats : 40Mbps
H.263	H.263	FLV (.flv) AVI (.avi)	V			Max Resolution: 1080P@60fps Max Bit Rats : 40Mbps
H.264	H.264	FLV (.flv) MP4 (.mp4) MPEG transport stream (.ts) ASF (.asf) WMV (.wmv) AVI (.avi) MKV (.mkv)	V			Max Resolution: 1080P@60fps Max Bit Rats : 135Mbps 4K2K@30fps
H.265	H.265	MP4 (.mp4) MPEG transport stream (.ts) MKV (.mkv)	V			Max Resolution: 4K2K@60fps Max Bit Rats : 100Mbps
GOOGLE VP8	VP8	MKV (.mkv) WebM (.webm)	V			Max Resolution: 1080P@30fps Max Bit Rats : 20Mbps
Motion JPEG	MJPEG	AVI (.avi) MP4 (.mp4) MKV (.mkv)	V			Max Resolution: 1920*1080 @30fps Max Bit Rats : 40Mbps

### Audio Decode

Type	Audio Codec	Container	Decode	Encode	Channel	Remark
MPEG Audio	MPEG1/2/2.5 Audio Layer1/2/3	MP3	V		2	Bit Rate: 8Kbps~320Kbps Sampling Rate: 16KHz~48KHz
Windows Media Audio	WMA Version 7, 8, 9, 10 pro M0, 10Pro M1, M10 Pro M2	Decode: WMA	V		2	Bit Rate: 8Kbps~768Kbps Sampling Rate: 8KHz~96(M10) KHz Non-support LBR
AAC Audio	MAIN, ADIF, ADTS Header for AAC-LC and AAC-HE	File Format: AAC, M4A	V		5.1	Bit Rate: N/A Sampling Rate: 8KHz~48KHz

## Image Decode

Type	Image Codec	Photo	Decode	Encode	Channel	Remark
JPEG	JFIF file format 1.02	File Format: JPG, JPEG	V			Max Resolution: 7000 x 7000 The limitation of max resolution depends on DRAM
BMP	BMP	File Format: BMP	V			Max Resolution: 15360 x 8640 The limitation of max resolution depends on DRAM
PNG	PNG	File Format: PNG	V			Max Resolution: 15360 x 8640 The limitation of max resolution depends on DRAM

### NOTES:

- Sound or video may not work if the contents have a standard bit rate/frame rate above the compatible Frame/sec listed in the table above.
- Video content with a Bit rate or Frame rate larger than the rate specified in the table above can cause choppy video during playback.

## 9. Input Mode

DVI/VGA timing support:

Item	Mode	Resolution	H.Freq. (KHz)	V.Freq. (Hz)
1	IBM VGA 10H	640x350	31.469	70.086
2	IBM VGA 12H	640x480	31.469	59.94
3	MACINTOSH	640x480	35	66.67
4	VESA	640x480	37.861	72.809
5	VESA	640x480	37.5	75
6	IBM VGA 3H	720x400	31.469	70.087
7	VESA	800x600	35.156	56.25
8	VESA	800x600	37.879	60.317
9	VESA	800x600	48.077	72.188
10	VESA	800x600	46.875	75.000
11	MACINTOSH	832x624	49.726	74.551
12	VESA Standard AddDMT	848x480	31	60.000
13	-	960x720	56.4	75.000
14	VESA	1024x768	48.363	60.004
15	VESA	1024x768	56.476	70.069
16		1152x864	53.986	59.985
17	VESA	1152x864	53.783	59.959
18		1152x864	63.851	70.012
19	VESA	1152x864	67.5	75.000
20	SUN WS	1152x900	61.846	66.004
21	-	1280x720	44.772	60.000
22	-	1280x720	52.5	70.000
23	CVT 2.3MA	1280 x768	47.776	59.870
24	CVT 2.3MA	1280 x768	60.289	74.893
25	CVT	1280x800	49.7	59.810
26	CVT	1280x800	62.8	74.930
27	VESA	1280x960	60	60.000
28	VESA	1280x1024	63.981	60.020
29	SUN WS	1280x1024	71.691	67.189
30	VESA	1280x1024	79.976	75.025
31	VESA Standard AddDMT	1360x768	47.712	60.015
32	VESA Standard AddDMT	1366x768	47.712	59.790
33	VESA-reduced blanking mode	1440x900	55.469	59.901
34	VESA	1440x900	55.935	59.887
35	VESA	1440x900	70.635	74.984
36	CVT-reduced blanking	1400x1050	64.744	59.948
37	CVT AddDMT	1440x1050	65.3	60.000
38	CVT	1400x1050	82.278	74.867
39	CVT Red. Blanking	1600x900	55.54	60.000
40	VESA	1600x1200	75	60
41	CVT1.76MW	1680x1050	65.29	59.954
42	CVT1.76MW-R	1680x1050	64.674	59.883
43	CVT 2.3MA-R	1920x1080	66.587	59.934
44	VESA Standard VDMTREV	1920x1080	67.5	60.000
45	CVT1960H	1920x1080	67.1584	59.963
46	VSC1960H	1920x1080	67.08	60
47	CVT 2.3MA-R	1920x1200	74.038	59.950

## 4K2K

Item	Resolution	H.Freq. (KHz)	V.Freq. (Hz)
1	3840x2160	53.946	23.900
2	3840x2160	54	24.000
3	3840x2160	56.25	25.000
4	3840x2160	67.432	29.900
5	3840x2160	67.5	30.000
6	4096x2160	54	24.000
7	3840x2160	135	60.000

## Video Timing support(HDMI/DVD HD/DVI)

Item	Mode	Resolution	Comment
1	60Hz	480i	except DVI
2		480p	
3		720p	
4		1080i	
5		1080p	
6		4Kx2K	except DVI
7	50Hz	576i	except DVI
8		576p	
9		720p	
10		1080i	
11		1080p	
12		4Kx2K	except DVI

Note: DisplayPort support 3840x2160@30Hz.

- The PC text quality is optimum in UHD 4K/2K mode(3840 x 2160, 60Hz).
- Your PC display screen might appear different depending on the manufacturer (and your particular version of Windows).
- Check your PC instruction book for information about connecting your PC to a display.
- If a vertical and horizontal frequency-select mode exists, select 60Hz (vertical) and 31.5KHz (horizontal). In some cases, abnormal signals (such as stripes) might appear on the screen when the PC power is turned off (or if the PC is disconnected). If so, press the [INPUT] button to enter the video mode. Also, make sure that the PC is connected.
- When horizontal synchronous signals seem irregular in RGB mode, check PC power saving mode or cable connections.
- The display settings table complies to the IBM/VESA standards, and based on the analog input.
- The DVI support mode is regarded as same to the PC support mode.
- The best timing for the vertical frequency to each mode is 60Hz.
- Resolution 3840x2160 50/60Hz must be equipped with HDMI certified cable(Premium High Speed HDMI Cables).

## 10. Pixel Defect Policy

We strive to deliver the highest quality products and use some of the industry's most advanced manufacturing processes whilst practicing stringent quality control. However, pixel or sub-pixel defects on the PDP / TFT panels used in Plasma- & LCD- displays are sometimes unavoidable. No manufacturer can guarantee that all panels will be free from pixel defects, but Philips guarantees that any Plasma- & LCD- displays with an unacceptable number of defects will be repaired during the warranty period in line with your local guarantee conditions.

This notice explains the different types of pixel defects and defines the acceptable defect level for the LCD screen. In order to qualify for repair under warranty, the number of pixel defects must exceed a certain level as shown in the reference table. If the LCD screen is within specification a warranty exchange / claim back will be refused. Additionally, because some types or combinations of pixel defects are more noticeable than others, Philips sets even higher quality standards for those.

### 10.1. Pixels and Sub-Pixels

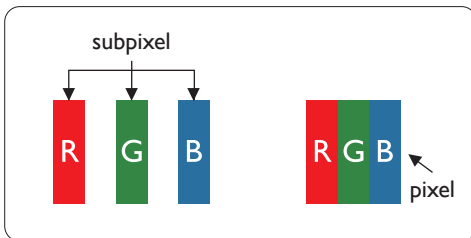

A pixel, or picture element, is composed of three sub-pixels in the primary colors of red, green and blue. Many pixels together form an image. When all sub-pixels of a pixel are lit, the three colored sub-pixels together appear as a single white pixel. When all are dark, the three colored sub-pixels together appear as a single black pixel. Other combinations of lit and dark sub-pixels appear as single pixels of other colors.

### 10.2. Types of Pixel Defects + Dot Definition

Pixel and sub-pixel defects appear on the screen in different ways. There are three categories of pixel defects and several types of sub-pixel defects within each category.

**Dot definition = What is a defective "Dot"?:**

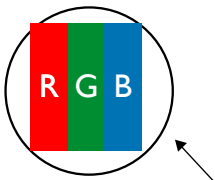

One or more defective, adjacent sub-pixel are defined as one "dot". The no. of defective sub-pixels are not relevant to define a defective dot. This means that a defective dot can consist of one, two or three defective sub-pixels which can be dark or lit.



One dot = One Pixel; consists of three sub-pixels of Red, Green, and Blue.

### 10.3. Bright Dot Defects

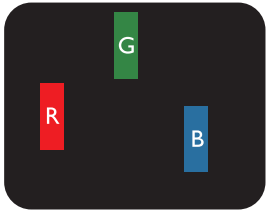
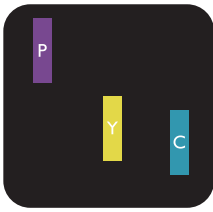
Bright dot defects appear as pixels or sub-pixels that are always lit or "on". These are the examples of bright dot defects:

 <p>One lit red, green or blue sub pixel</p>	 <p>Two adjacent lit sub pixels:            Red + Blue = Purple            Red + Green = Yellow            Green + Blue = Cyan (Light Blue)</p>	 <p>Three adjacent lit sub pixels (one white pixel)</p>
---	--	--

## 10.4. Dark Dot Defects

Black dot defects appear as pixels or sub-pixels that are always dark or "off". These are the examples of black dot defects:

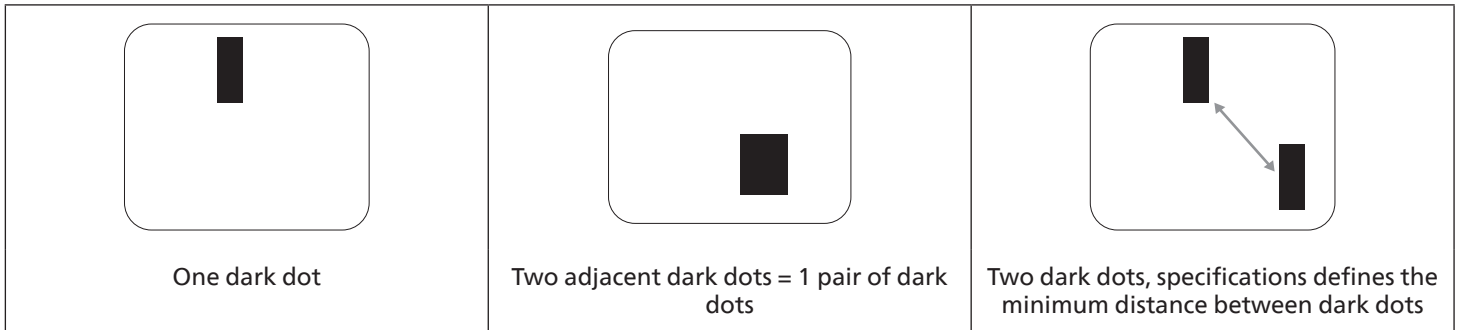

## 10.5. Proximity of Pixel Defects

Because pixel and sub-pixels defects of the same type that are nearby one another may be more noticeable, Philips also specifies tolerances for the proximity of pixel defects. In the table below you can find specifications about:

- Allowed amount of adjacent dark dots = (adjacent dark dots = 1 pair of dark dots)
- Minimum distance between dark dots
- Total no. of all defective dots

## 10.6. Pixel Defect Tolerances

In order to qualify for repair due to pixel defects during the warranty period, a PDP / TFT panel in a Philips Plasma / LCD- display must have pixel or sub-pixel defects exceeding the tolerances listed in the following table.

BRIGHT DOT EFFECT	ACCEPTABLE LEVEL
1 lit sub pixel	2
BLACK DOT EFFECT	ACCEPTABLE LEVEL
1 dark sub pixel	10
TOTAL DOT DEFECTS OF ALL TYPES	12

NOTE: \* 1 or 2 adjacent sub pixel defects = 1 dot defect

## 10.7. MURA

Dark spots or patches may occasionally appear on some liquid crystal display (LCD) panels. This is known within the industry as Mura, which is a Japanese term for "unevenness." It is used to describe an irregular pattern or area in which uneven screen uniformity appears under certain conditions. Mura is a result of the deterioration of the liquid crystal alignment layer and is most commonly caused by long-term operation under high ambient temperatures. It is an industry- wide phenomenon and Mura is not repairable. It is also not covered by our warranty terms.

Mura has been around since the introduction of LCD technology and with screens getting bigger and in operation 24/7, many displays are running in low light conditions. This all adds to the possibility of Mura affecting displays.

### HOW TO SPOT MURA

There are many symptoms of Mura and also multiple causes. Several of these are listed below:

- Impurities or foreign particles in the crystal matrix
- Uneven distribution of LCD matrix during manufacturing
- Non-uniform luminance distribution of the backlight
- Panel assembly induced stress
- Flaws within the LCD cells
- Thermal induced stress - high temperature operation over long periods of time



## HOW TO AVOID MURA

Although we can not guarantee the complete eradication of Mura every time, in general the appearance of Mura can be minimized by these methods:

- Lower the backlight brightness
- Use a screen saver
- Reduce the ambient temperature around the unit

# 11. Cleaning and Troubleshooting

## 11.1. Cleaning

### Caution When Using the Display

- Do not bring your hands, face or objects close to the ventilation holes of the display. The top of the display is usually very hot due to the high temperature of exhaust air being released through the ventilation holes. Burns or personal injuries may occur if any body parts are brought too close. Placing any object near the top of the display could also result in heat related damage to the object as well as the display itself.
- Be sure to disconnect all cables before moving the display. Moving the display with its cables attached may damage the cables and thus cause fire or electric shock.
- Disconnect the power plug from the wall outlet as a safety precaution before carrying out any type of cleaning or maintenance procedure.

### Front Panel Cleaning Instructions

- The front of the display has been specially treated. Wipe the surface gently using only a cleaning cloth or a soft, lint-free cloth.
- If the surface becomes dirty, soak a soft, lint-free cloth in a mild detergent solution. Wring the cloth to remove excess liquid. Wipe the surface of the display to remove dirt. Then use a dry cloth of the same type to dry.
- Do not scratch or hit the surface of the panel with fingers or hard objects of any kind.
- Do not use volatile substances such as insert sprays, solvents and thinners.

### Cabinet Cleaning Instructions

- If the cabinet becomes dirty, wipe the cabinet with a soft, dry cloth.
- If the cabinet is extremely dirty, soak a lint-free cloth in a mild detergent solution. Wring the cloth to remove as much moisture as possible. Wipe the cabinet. Use another dry cloth to wipe over until the surface is dry.
- Do not use solution that contains oil to clean the plastic parts. Such product damage the plastic parts and void the warranty.
- Do not allow any water or detergent to come into contact with the surface of the display. If water or moisture gets inside the unit, operating problems, electrical and shock hazards may result.
- Do not scratch or hit the cabinet with fingers or hard objects of any kind.
- Do not use volatile substances such as insert sprays, solvents and thinners on the cabinet.
- Do not place anything made from rubber or PVC near the cabinet for any extended periods of time.

## 11.2. Troubleshooting

Symptom	Possible Cause	Remedy
No picture is displayed	<ol style="list-style-type: none"> <li>1. The power cord is disconnected.</li> <li>2. The main power switch on the back of the display is not switched on.</li> <li>3. The selected input has no connection.</li> <li>4. The display is in standby mode.</li> </ol>	<ol style="list-style-type: none"> <li>1. Plug in the power cord.</li> <li>2. Make sure the power switch is switched on.</li> <li>3. Connect a signal connection to the display.</li> </ol>
Interference displayed on the display or audible noise is heard	Caused by surrounding electrical appliances or fluorescent lights.	Move the display to another location to see if the interference is reduced.
Color is abnormal	The signal cable is not connected properly.	Make sure that the signal cable is attached firmly to the back of the display.
Picture is distorted with abnormal patterns	<ol style="list-style-type: none"> <li>1. The signal cable is not connected properly.</li> <li>2. The input signal is beyond the capabilities of the display.</li> </ol>	<ol style="list-style-type: none"> <li>1. Make sure that the signal cable is attached firmly.</li> <li>2. Check the video signal source to see if it is beyond the range of the display. Please verify its specifications with this display's specification section.</li> </ol>
Display image doesn't fill up the full size of the screen	<ol style="list-style-type: none"> <li>1. The zoom mode is not set correctly.</li> <li>2. Scan Mode may be set incorrectly to underscan.</li> <li>3. If the image exceeds the screen size, Scan Mode may need to be set to Underscan.</li> </ol>	Use the Zoom mode or Custom zoom function in the Screen menu to fine tune display geometry and time frequency parameter.
Can hear sound, but no picture	Source signal cable is connected improperly.	Make sure that both video inputs and sound inputs are correctly connected.
Can see picture but no sound is heard	<ol style="list-style-type: none"> <li>1. Source signal cable is connected improperly.</li> <li>2. Volume is turned all the way down.</li> <li>3. {Mute} is turned on.</li> <li>4. No external speaker connected.</li> </ol>	<ol style="list-style-type: none"> <li>1. Make sure that both video inputs and sound inputs are correctly connected.</li> <li>2. Press [+] or [-] button to hear sound.</li> <li>3. Switch MUTE off by using the [MUTE] button.</li> <li>4. Connect external speakers and adjust the volume to a suitable level.</li> </ol>
Some picture elements do not light up	Some pixels of the display are off.	This display is manufactured using an extremely high level of precision technology: however, sometimes some pixels of the display may not display. This is not a malfunction.
After-Images can still be seen on the display after the display is powered off. (Examples of still pictures include logos, video games, computer images, and images displayed in 4:3 normal mode)	A still picture is displayed for an over extended period of time	Do not allow a still image to be displayed for an extended period of time as this can cause a permanent after-image to remain on the display.

## 12. Technical Specifications

### Display:

Item	Specifications
Screen Size (Active Area)	247.6 cm / 97.5 inch
Aspect Ratio	16:9
Number of pixels	3840 (H) x 2160 (V)
Pixel pitch	0.562 (H) x 0.562 (V) [mm]
Displayable colors	8 bits+FRC, 1.07 Billion colors
Brightness (typical)	500 cd/m <sup>2</sup>
Contrast ratio (typical)	1200:1
Viewing angle	178 degrees

### In/Out Terminals:

Item	Specifications
Speaker Output	Internal Speakers 10W (L) + 10W (R) [RMS]/8Ω 82 dB/W/M/160 Hz - 13 KHz
Audio Output	3.5mm phone jack x 1 0.5V [rms] (Normal) / 2 Channel (L+R)
Audio Input	3.5mm phone jack x 1 0.5V [rms] (Normal) / 2 Channel (L+R)
RS232	2.5mm Phone jack x 2 RS232 in/RS232 out
RJ-45	RJ-45 Jack x 1 (8 pin) 10/100/1000 LAN Port
HDMI Input	HDMI Jack x2 (Type A) (19 pin) Digital RGB: TMDS (Video + Audio) MAX: Video - 720p, 1080p, 3840 x 2160/60 Hz Audio - 48 KHz/ 2 Channel (L+R) Supports LPCM only
DVI-I Input	DVI-I Jack Digital RGB: TMDS (Video) Analog RGB: 0.7V [p-p] (75Ω), H/CS/V: TTL (2.2kΩ), MAX: 1920 x 1080/60 Hz (WUXGA)
Displayport in/out	Displayport Jack x 2 (20 pin) Digital RGB: TMDS (Video + Audio) MAX: Video - 720p, 1080p, 3840 x 2160/60 Hz Audio - 48 KHz / 2 Channel (L+R) Supports LPCM only
IR Input/Output	3.5mm x 2 IR pass through or IR daisy chain
OTG	Micro USB Support service and ADB data transmission
USB Input	USB3.0 x 2 (Type A) USB Multimedia play
Expansion slot	USB 3.0 x 1 Reserve for CRD22

**General:**

Item	Specifications
Power Input	100 - 240V~, 50/60Hz
Power Consumption (Max)	296 W
Power Consumption (Typ.)	209 W
Power Consumption (Standby mode & Off mode)	<0.5 W
AC Switch Off Mode (W)	0 W
Dimensions (Without Stand) [W x H x D]	2193.4 x 1255.3 x 94.1 mm (@Handle) / 90.0 mm (@Wall mount)
Weight (Without Stand)	65.64 Kg
Gross Weight (Without Stand)	82.2 Kg

**Environmental Condition:**

Item		Specifications
Temperature	Operational	0 - 40°C
	Storage	-20 - 60°C
Humidity	Operational	20 - 80% RH (No condensation)
	Storage	5 - 95% RH (No condensation)
Altitude	Operational	0 - 3,000 m
	Storage / Shipment	0 - 9,000 m

## Warranty policy for Philips Professional Display Solutions

Thank you for purchasing this Philips product. Philips products are designed and manufactured with high standards and deliver high quality performance, ease of use and ease of installation. If you encounter any difficulties while using your product, we recommend that you first consult the user manual or the information in the support section of the website, where (depending on the product type) you may find a downloadable user manual, frequently asked questions, instruction videos or a support forum.

### LIMITED WARRANTY

In the unlikely event the product requires service, we will arrange for your Philips product to be serviced free-of-charge within the warranty period, provided that the product was used in accordance with the user manual (e.g. in the intended environment).

For these product categories, a partner company of Philips is the warrantor of the product. Please check the documentation supplied with your product.

### WHO IS COVERED?

Your Warranty coverage begins from the first date of purchase of the product. You need to provide proof of purchase to receive warranty service. A valid sales receipt or other valid document showing that you purchased the product is considered proof of purchase.

### WHAT IS COVERED?

If any defect due to faulty materials and/or workmanship occurs within the warranty period, we will make arrangements for a free of charge service. Where a repair is not possible or not commercially viable, we may replace the product with a new or equivalent refurbished product with similar functionality. Replacement will be offered at our discretion and the warranty will continue from the date of original purchase of the first date of purchase of the product. Please note that all parts, including repaired and replaced parts, are covered only for the duration of the original warranty period.

### WHAT IS EXCLUDED? Your warranty does not cover:

- Consequential damages (including but not limited to loss of data or loss of income), nor compensation for activities done by yourself, such as regular maintenance, installing firmware updates or saving or restoring data (Some states do not allow the exclusion of incidental or consequential damages, so the above exclusion may not apply to you. This includes, but is not limited to, prerecorded material, whether copyrighted or not copyrighted.)
- Labor charges for installation or setup of the product, adjustment of customer controls on the product, and installation or repair of various types of external devices (e.g., WiFi, antenna, USB dongles, OPS type devices) and other systems outside of the product.
- Reception problems caused by signal conditions or cable or antenna systems outside the unit.
- A product that requires modification or adaptation to enable it to operate in any country other than the country for which it was designed, manufactured, approved and/or authorized, or repair of products damaged by these modifications.
- If the model or production number on the product has been altered, deleted, removed or made illegible.

The warranty applies on condition that the product has been handled properly for its intended use and in accordance with the operating instructions

#### To Obtain Warranty Service And Information

For detailed warranty coverage information and additional support requirement and help line, please contact the seller and/or system integrator you purchased the product from. Please note in the USA, this limited warranty is only valid for Products purchased in the Continental United States, Alaska, and Hawaii.

#### Before Requesting Service

Please check your user's manual before requesting service. Adjustments of the controls discussed there may save you a service call.

#### WARRANTY PERIOD

Warranty period for PHILIPS signage display is listed as below, for areas not covered in this table, please follow their warranty statement.

Standard warranty period for PHILIPS signage display is listed as below, for areas not covered in this table, please follow the local warranty statement.

Region	Standard Warranty Period
USA, Canada	3 years
China	1 year
Japan	3 years
Rest of world	3 years
Mexico	3 years
Brazil	3 years
Chile	3 years
Peru	3 years

Note that for professional products, the specific warranty terms of the sale- or purchase agreement may apply.

# Index

## A

AC Switch Cover 24

## B

Browser 35

## C

Change Picture Format 30

Cleaning and Troubleshooting 75

Connecting a PC 26

Connecting Audio Equipment 27

Connecting External Equipment 26

Connecting External Equipment (Multimedia Player) 26

Connecting Multiple Displays in a Daisy-chain  
Configuration 28

Control Panel 16

Custom App 42

## H

Handling the remote control 22

## I

Input Mode 71

Input/Output Terminals 17

Inserting the batteries in the remote control 22

Installation Notes 13

IR connection 28

IR Pass-through Connection 28

## M

Media Player 32

Mounting in Portrait Orientation 15

Mounting on a Wall 14

## N

Navigating the OSD Menu 59

## O

Operating range of the remote control 22

Operation 30

OSD Menu 59

OSD Menu Overview 59

Overview 30

## P

Package Contents 13

Parts and Functions 16

PDF Player 39

Pixel Defect Policy 73

## R

Remote Control 18

## S

Safety Instructions 1

Setting 43

Supported Media Formats 69

## T

Technical Specifications 77

## U

Unpacking 10

Unpacking and Installation 10

USB Cover 23

## W

Warranty policy for Philips Professional Display Solutions  
79

Watch the Connected Video Source 30

Wire-connecting to Network 29



2024 © TOP Victory Investments Ltd. All rights reserved.

This product has been manufactured by and is sold under the responsibility of Top Victory Investments Ltd., and Top Victory Investments Ltd. is the warrantor in relation to this product. Philips and the Philips Shield Emblem are registered trademarks of Koninklijke Philips N.V. and are used under license.

Specifications are subject to change without notice.

Version: V1.01 2024-10-16